

INDUSTRIE

FORSCHUNG
LABOR
AUSBILDUNG

Innovative.
Dynamic.
Timeless.



QUADRO.

KARL original.



The table for a thousand **ideas**

QUADRO is as changeable as the products that are created on it. Tailored to the complex work processes in assembly, laboratory, QUADRO does not allow any research institutions or apprenticeships wishes open. You can design it exactly how you want it and the purpose requires it.

QUADRO is much more than a table. As a premium product from Karl, the table system combines high quality workmanship, excellent functionality and well-engineered ergonomics for a modern, innovative workplace system.

With its timeless design, light gray base color and decorative colored accents, QUADRO ensures a positive and motivating atmosphere in the workplace and helps release energy and creativity.

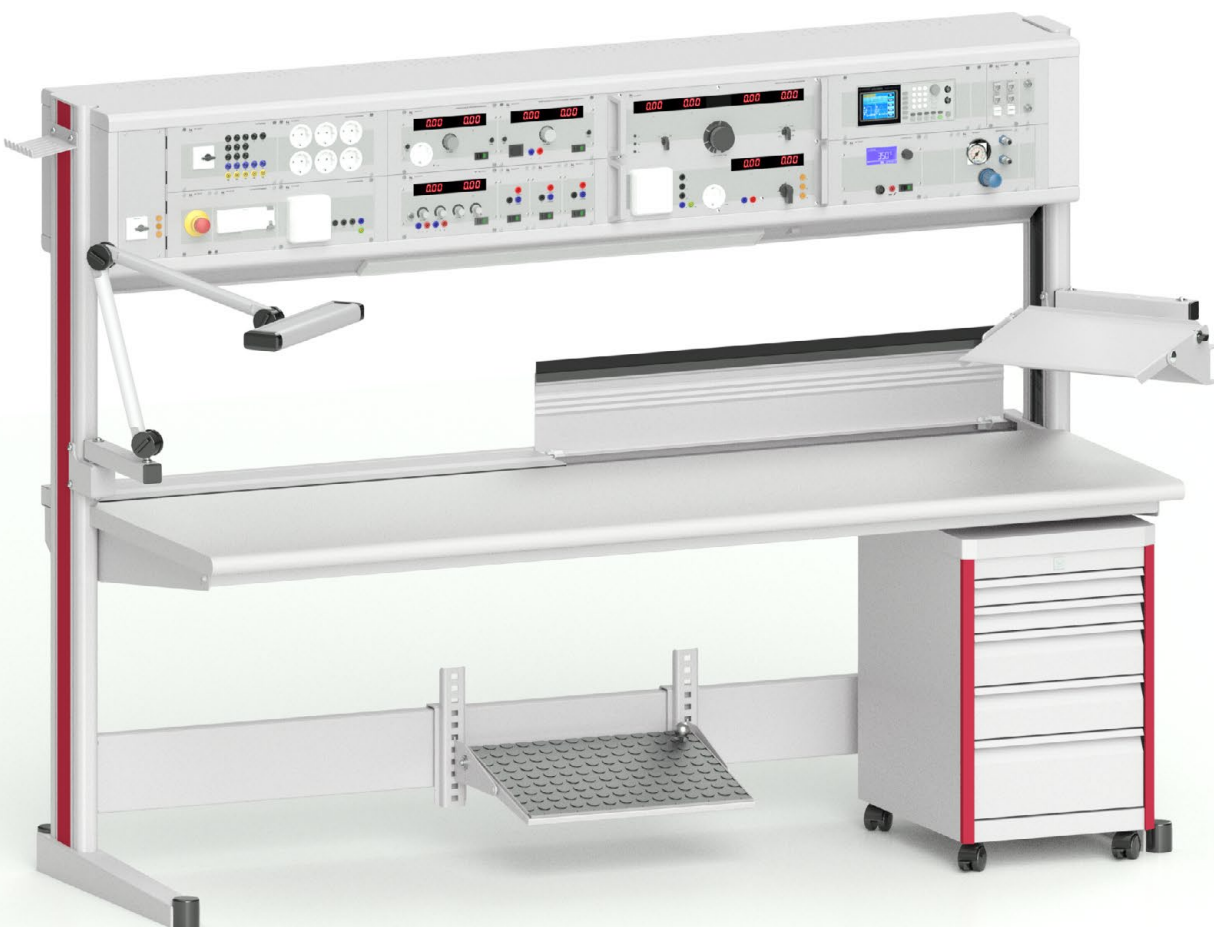

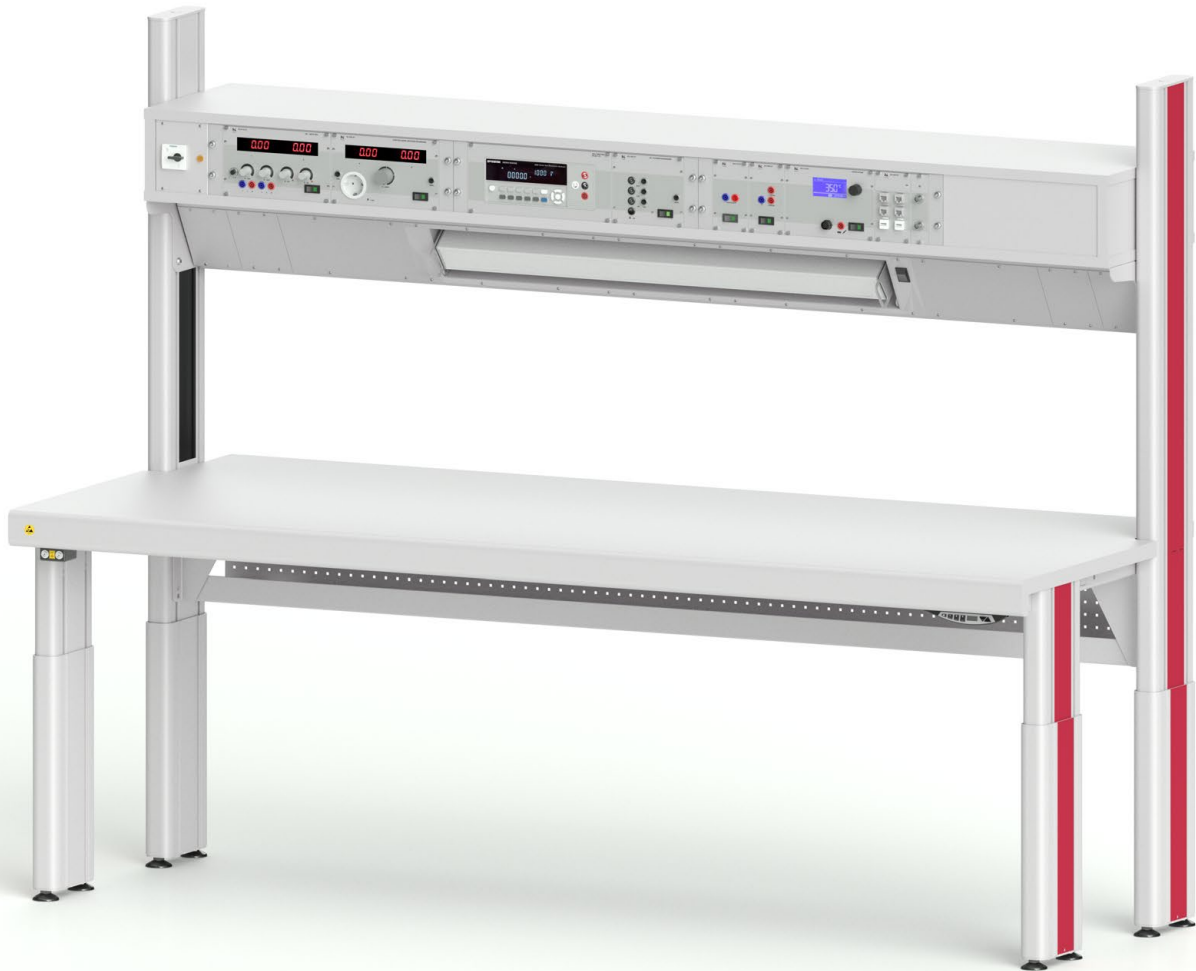

Versatile: QUADRO for **research and laboratory**

Inconspicuous, intelligent and efficient. With these properties, the QUADRO manages power and media cables. Whether horizontal or vertical cable management - the end-to-end cable management organizes and stows away all the necessary cables. Future-oriented work also allows the 19-inch structure for the integration of function and supply modules.

Requirements are constantly changing, especially in research and laboratories. QUADRO grants researchers and technicians the flexibility they need to be up to date.

Teach and learn: QUADRO for **training**

The individually combinable modules form the perfect basis for the diverse requirements of industrial and school training.

QUADRO thus not only creates an environment that signals appreciation and promotes concentrated learning. Thanks to the practical experimental setups, the trainees also learn all the basics for their future profession.





One table, many options: QUADRO for **industry**

Efficiency and safety, productivity and motivation are through one ergonomically and functionally designed workstation sustainably increased. QUADRO meets all ergonomic requirements for a modern table system without compromising on stability and function. Optimal reach, material supply, energy and media supply - QUADRO supports changing work postures, offers a high level of working comfort, well thought-out functionality and sophisticated ergonomics.

The extensive range of accessories makes QUADRO a highly flexible table and offers a maximum of individual combination options that can be redesigned, changed and expanded at any time. For every production strategy, QUADRO offers a comprehensive program for the low-waste and ergonomic design of assembly processes.

Ergonomics, Functionality, Design. **QUADRO is everything in one.**

With great attention to detail, the **QUADRO** table system is designed to that it meets your requirements for efficiency to the highest degree, quality and ergonomics.

The linear design, the light gray base color and tasteful color accents radiate timeless modernity and emphasize the high quality of **QUADRO**. **QUADRO** is optional for perfect ergonomics in the workplace equipped with an electric height adjustment.

In the ESD version, the table system fulfills all requirements of IEC 61340-5-1 and is therefore ideally suited for use in an EPA.



QUADRO offers everything for assembly-oriented workplace options for ergonomic design according to the requirements of lean production.

Leave the tabletop, storage boards and all add-on elements position yourself continuously variable in height.

QUADRO is full of energy:
Mains voltage, data and communication interfaces are available where they are needed.
Measurement and testing technology can be used in a 19" structure can be integrated above the work surface.
All cables and lines are installed in a concealed manner.

Tasteful color accents, the concise column profile and rounded edges are visually appealing quality features and emphasize the high quality from **QUADRO**.



QUADRO.

KARL original.

Table frames

QUADRO with C-foot

Basic and add-on tables	13
Table system in basic equipment	13
Table system with integrated Schuko sockets	14
Table system with cable tray	15
Table system including cable tray with flap	16
Individual assemblies	17
QUADRO columns	17
Column extension	17
Table tops	18

QUADRO twin 300

Manually height adjustable	19
Framework	20
Columns	21
Table tops	24

QUADRO twin 400

Manually height adjustable with adjustable foot	33
Framework	34
Columns	35
Table tops	38

QUADRO twin 500

Manually height adjustable with clamp	47
Framework	48
Columns	49
Table tops	52

QUADRO twin 600

Height adjustable with electrohydraulics	61
Framework	62
Columns	63
Table tops	66

QUADRO twin 700

Height adjustable with spindle drive	74
Framework	75
Columns	76
Table tops	79

Table extension elements

Table extension elements for QUADRO . . . 87

Boom	87
Running rail	87
Storage shelf made of sheet steel	87
Storage board for gripping trays	88
Carrier rail for socket strips	88
ESD regulations holder	88
Flat screen bracket	89
Keyboard drawer	89
PC tower holder	89
Privacy screen	90
ESD footrest	90

Table extension elements for QUADRO twin 91

Boom	91
Storage shelf made of sheet steel	91
Storage board made of wood	91

Wooden filing board with terminal	92
Carrier rail for socket strips	92
Cable tray with integrated privacy screen	92
ESD regulations holder	93
Flat screen bracket	93
Keyboard drawer	93
PC tower holder	94
ESD footrest	94

Multifunction arm VARIO 95

Flat screen bracket	95
Swiveling storage board	95
Universal frame	96
Attachable storage board	96
Attachable storage board for grab trays	96
Tool holder wall	96
Carrier rail for grab trays	97
Storage board for grab trays	97
Grab tray container	97
Grab shells	97

Drawer blocks 98

Single drawer	98
Drawer block F4	98
Drawer block F1	99
Drawer block F0	99
Mobile drawer block F0	100
ESD insert tray for small parts	101
Variable cross and lengthways subdivisions	101

Electrical equipment

Electrical equipment for QUADRO 102

19"-superstructures made of sheet steel	102
19"-superstructures made of wood	103
Electrical connection strips	104
Electrical insert strips	105

Electrical equipment for QUADRO twin . . 106

19"-superstructures made of wood	106
LED linear luminaire for terminal	106
Electrical connection strips	107
Electrical insert strips	107

Power supply 108

Insert plates for electrical connection strips	108
Connection cable	110

Lighting 112

LED linear luminaire	112
LED articulated arm light	113
LED magnifying lamp	113

Office chairs 114

QUADRO-CAR 115

Filing board	118
19"-superstructures	119
Drawer blocks	120

QUADRO

with C-foot

- **Table height: individual**
- stepless height adjustment of the table top and the accessories
- load capacity: max. surface load 200 kg



Page 10

QUADRO twin 300

Manually height adjustable

- **Table height: height adjustment range 765 - 785 mm**
- 20 mm height adjustable
- load capacity: max. surface load 200 kg

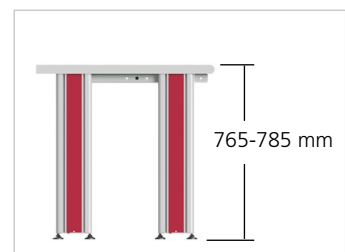

Page 19

QUADRO twin 400

Manually height adjustable with adjustable foot

- **Table height: height adjustment range 735 - 835 mm**
- 100 mm height adjustable
- load capacity: max. surface load 200 kg

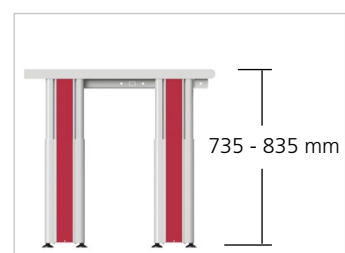

Page 33

QUADRO twin 500

Manually height adjustable with clamp

- **Table height: height adjustment range 735 - 955 mm**
- 220 mm height adjustable
- load capacity: max. surface load 200 kg

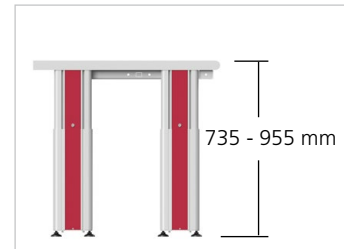

Page 47

QUADRO twin 600

Height adjustable with electrohydraulics drive

- **Table height: height adjustment range 730 - 1070 mm**
- 340 mm height adjustable
- load capacity: max. surface load 200 kg
- electric drive with intelligent control
- cable remote control with digital display and 4 position memories

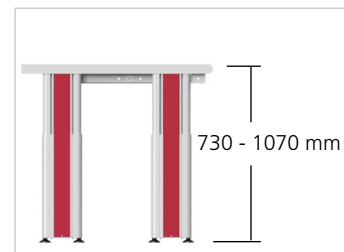

Page 61

QUADRO twin 700

Height adjustable with spindle drive

- **Table height: height adjustment range 730 - 1070 mm**
- 340 mm height adjustable
- load capacity: max. surface load 200 kg
- electric drive with intelligent control
- cable remote control with digital display and 3 position memories

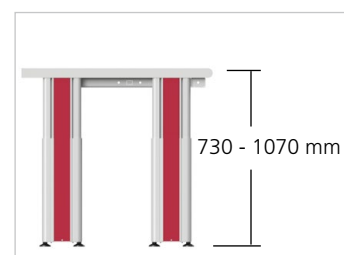

Page 74

QUADRO with C-foot

- **Table height: individual**
- stepless height adjustment of the table top and accessories
- load capacity: max. surface load 200 kg
- steel frame for mounting the table top
- cross connection between the QUADRO columns for stabilization
- QUADRO column made of aluminum as a functional and optical basic element
- conductive powder-coated, light gray (RAL 7035)
- color accents with decorative elements in the pillars
- foot part with two easy-to-use, conductive height adjustment elements for leveling the workbench
- ESD version with central earthing point for connecting the ESD or protective earth



Columns

- QUADRO column made of aluminum as a functional and optical basic element
- conductive powder-coated, light gray (RAL 7035)
- color accents with decorative elements in the pillars
- conductive height adjustment elements in the foot parts
- legroom with corner table combinations thanks to shortened foot sections

Position of the brush strip and the brush elements

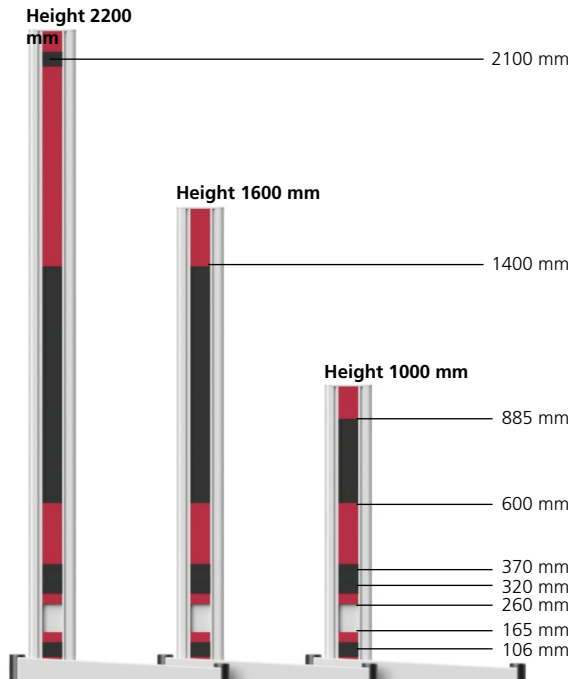

Position of the optional sockets

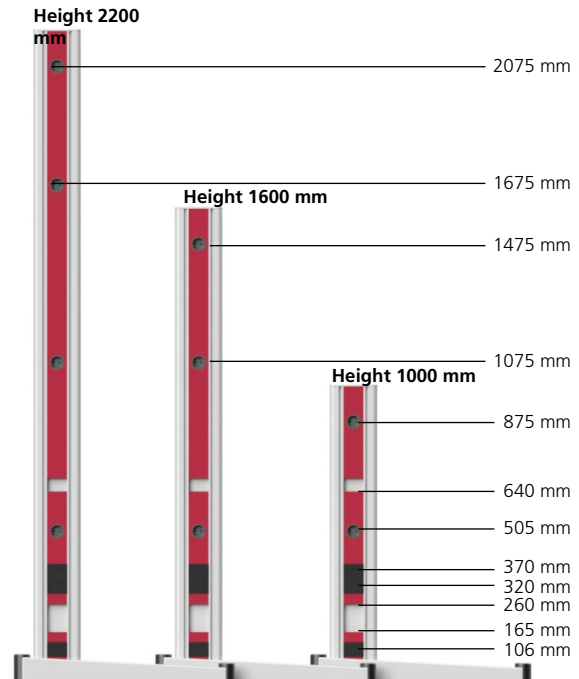

with decorative element	with brush element	with Schuko sockets	with Swiss sockets
-------------------------	--------------------	---------------------	--------------------

Energy, compressed air and data lines can be installed in the two cable ducts of the QUADRO columns be relocated.

Integrated brush strips e.g. for cable routing in connection with cable tray and / or 19" structure.

Integrated Schuko sockets on the inside e.g. for electrifying the upper shelves.

Integrated Swiss sockets on the inside e.g. to electrify the upper shelves.

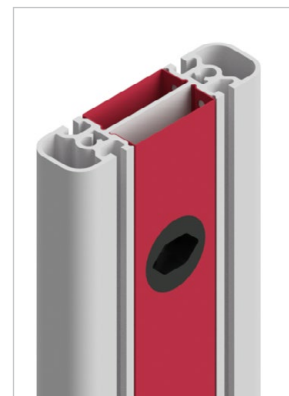
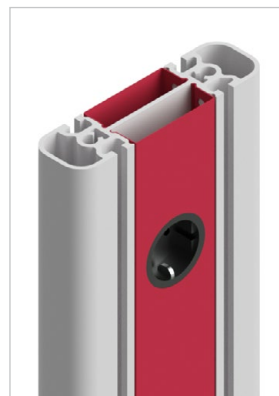
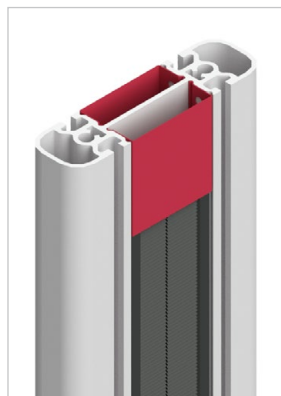
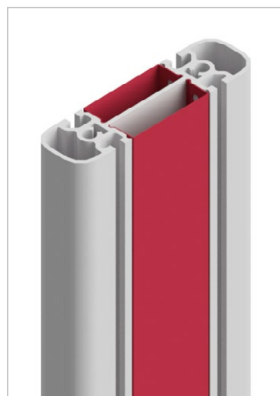

Table tops

- light gray table top (RAL 7035), 40 mm thick
- protected with robust edge band
- at the front with rounded postformed edge
- slightly structured surface, glare-free and highly scratch-resistant
- briefly heat-resistant up to 180°C
- resistant to organic solvents, weak acids and alkalis, gasoline and oil
- steplessly mountable, minimum height for mobile drawer blocks: 780 mm



Standard:

- Hard laminate (EN 438)
- very hard and abrasion-resistant HPL laminate

ESD version:

- conductive ESD Hard laminate (EN 438)
- very hard and abrasion-resistant, conductive HPL laminate
- volume conductive carrier plate
- leak resistance 10^9 Ohm (dry measurement according to IEC 61340-5-1, 100 V)
- grounding box with two 10 mm push-button connections
- central earthing point for connecting the ESD or protective earth



Table top including cable tray and cable duct

- sheet steel cable tray under the table top with access to the QUADRO columns
- rear table top with two integrated cable ducts (Ø 80 mm) as access to the cable tray
- including cable entry sets



Table top including cable tray with flap

- cable tray integrated in the table top with hinged cover
- cable tray D = 230 mm, table top D = 650 mm
- cover divided in the middle for table widths of 1650 mm and 2135 mm
- with brush strip for cable entry when the cover is closed

Optional:

- electrical insert strip, prepared for individual assembly with insert plates (page 105)
 - table width 1300 mm: 1100 mm usable width for insert plates
 - table width 1650 mm: 1400 mm usable width for insert panels
 - table width 2135 mm: 1800 mm usable width for insert plates



Basic and add-on tables

- Table top depth: 880 mm, 3 different table widths, 3 different column heights
- Extension table optionally with long (690 mm) or short (500 mm) foot section for optimal legroom in rows of tables
- Basic and add-on tables can be combined to form rows of tables of any length
- the middle QUADRO column is used twice, the table tops connect seamlessly to each other, whereby the possibility of individual height adjustment is retained
- openings in the QUADRO column enable continuous electrification of the row of tables

Table system in basic equipment

- Basic table and add-on table with long foot section: QUADRO column with inside brush strip
- Extension table with short foot section: QUADRO column with brush strips on both sides

Basic table

table width	1300 mm	1650 mm	2135 mm
column height 1000 mm	10.005. __	10.025. __	10.045. __
column height 1600 mm	10.010. __	10.030. __	10.050. __
column height 2200 mm	10.015. __	10.035. __	10.055. __

Extension table with long foot section

table width	1300 mm	1650 mm	2135 mm
column height 1000 mm	10.006. __	10.026. __	10.046. __
column height 1600 mm	10.011. __	10.031. __	10.051. __
column height 2200 mm	10.016. __	10.036. __	10.056. __

Add-on table with a short foot section

table width	1300 mm	1650 mm	2135 mm
column height 1000 mm	10.007. __	10.027. __	10.047. __
column height 1600 mm	10.012. __	10.032. __	10.052. __
column height 2200 mm	10.017. __	10.037. __	10.057. __







Please add an ESD key and a color key for the decorative elements to the article number:

ESD key

not conductive	__ . __ . __ . 1 _
conductive	__ . __ . __ . 2 _

Decor color

 water blue (RAL 5021)	__ . __ . __ . 2
 cobalt blue (RAL 5013)	__ . __ . __ . 3
 raspberry red (RAL 3027)	__ . __ . __ . 4
 zinc yellow (RAL 1018)	__ . __ . __ . 6
 pigeon blue (RAL 5014)	__ . __ . __ . 8

Other colors for realizing your corporate identity on request

Table system with integrated Schuko sockets

- depending on the column height, with 2, 3 or 4 fully wired Schuko sockets in a QUADRO column, ready for connection with WINSTA plug



Basic table

table width	1300 mm	1650 mm	2135 mm
column height 1000 mm	10.105. __	10.125. __	10.145. __
column height 1600 mm	10.110. __	10.130. __	10.150. __
column height 2200 mm	10.115. __	10.135. __	10.155. __



Extension table with long foot section

table width	1300 mm	1650 mm	2135 mm
column height 1000 mm	10.106. __	10.126. __	10.146. __
column height 1600 mm	10.111. __	10.131. __	10.151. __
column height 2200 mm	10.116. __	10.136. __	10.156. __

Add-on table with a short foot section

table width	1300 mm	1650 mm	2135 mm
column height 1000 mm	10.107. __	10.127. __	10.147. __
column height 1600 mm	10.112. __	10.132. __	10.152. __
column height 2200 mm	10.117. __	10.137. __	10.157. __



Equipment





3 m power cord with Schuko plug and WINSTA socket	95.625.98
3 m power cord with Swiss plug and WINSTA socket	95.627.98

Please add an ESD key and a color key for the decorative elements to the article number:

ESD key

not conductive	__ . __ . __ . 1 _
conductive	__ . __ . __ . 2 _

Decor color

 water blue (RAL 5021)	__ . __ . __ . 2
 cobalt blue (RAL 5013)	__ . __ . __ . 3
 raspberry red (RAL 3027)	__ . __ . __ . 4
 zinc yellow (RAL 1018)	__ . __ . __ . 6
 pigeon blue (RAL 5014)	__ . __ . __ . 8

Other colors for realizing your corporate identity on request

Table system with cable tray and cable duct

- Sheet steel cable tray under the table top with access to the QUADRO columns
- Table top at the back with two integrated cable ducts (Ø 80 mm) as access to the cable tray



Basic table

table width	1300 mm	1650 mm	2135 mm
column height 1000 mm	10.205. __	10.225. __	10.245. __
column height 1600 mm	10.210. __	10.230. __	10.250. __
column height 2200 mm	10.215. __	10.235. __	10.255. __

Extension table with long foot section

table width	1300 mm	1650 mm	2135 mm
column height 1000 mm	10.206. __	10.226. __	10.246. __
column height 1600 mm	10.211. __	10.231. __	10.251. __
column height 2200 mm	10.216. __	10.236. __	10.256. __

Add-on table with a short foot section

table width	1300 mm	1650 mm	2135 mm
column height 1000 mm	10.207. __	10.227. __	10.247. __
column height 1600 mm	10.212. __	10.232. __	10.252. __
column height 2200 mm	10.217. __	10.237. __	10.257. __



Equipment





5-way Schuko socket strip 16 A, 250 V with switch, 1.5 m power cord and Schuko plug	95.005.98
5-way Schuko socket strip 16 A, 250 V with switch, 1.5 m power cord and Swiss plug	95.004.98

Please add an ESD key and a color key for the decorative elements to the article number:

ESD key

not conductive	__ . __ . __ . 1 _
conductive	__ . __ . __ . 2 _

Decor color

 water blue (RAL 5021)	__ . __ . __ . 2 _
 cobalt blue (RAL 5013)	__ . __ . __ . 3 _
 raspberry red (RAL 3027)	__ . __ . __ . 4 _
 zinc yellow (RAL 1018)	__ . __ . __ . 6 _
 pigeon blue (RAL 5014)	__ . __ . __ . 8 _

Other colors for realizing your corporate identity on request

Table system including cable tray with flap

- cable tray in the rear area of the table top, easily accessible through hinged covers
- brushes embedded in the cover for easy cable routing when closed
- side openings as access to the QUADRO columns
- the cable tray with flap can be equipped with an electrical insert strip for individual fitting with insert plates for energy, data and media supply (page 105)
- table top depth: 650 mm



Basic table

table width	1300 mm	1650 mm	2135 mm
column height 1000 mm	10.305. __	10.325. __	10.345. __
column height 1600 mm	10.310. __	10.330. __	10.350. __
column height 2200 mm	10.315. __	10.335. __	10.355. __



Extension table with long foot section

table width	1300 mm	1650 mm	2135 mm
Column height 1000 mm	10.306. __	10.326. __	10.346. __
Column height 1600 mm	10.311. __	10.331. __	10.351. __
Column height 2200 mm	10.316. __	10.336. __	10.356. __

Add-on table with a short foot section

table width	1300 mm	1650 mm	2135 mm
Column height 1000 mm	10.307. __	10.327. __	10.347. __
Column height 1600 mm	10.312. __	10.332. __	10.352. __
Column height 2200 mm	10.317. __	10.337. __	10.357. __







Please add an ESD key and a color key for the decorative elements to the article number:

ESD key

not conductive	__ . __ . __ . 1 _
conductive	__ . __ . __ . 2 _

Decor color

 water blue (RAL 5021)	__ . __ . __ . 2 _
 cobalt blue (RAL 5013)	__ . __ . __ . 3 _
 raspberry red (RAL 3027)	__ . __ . __ . 4 _
 zinc yellow (RAL 1018)	__ . __ . __ . 6 _
 pigeon blue (RAL 5014)	__ . __ . __ . 8 _

Other colors for realizing your corporate identity on request

Individual assemblies

for special solutions, e.g. corner or U-combinations, different column heights

QUADRO columns

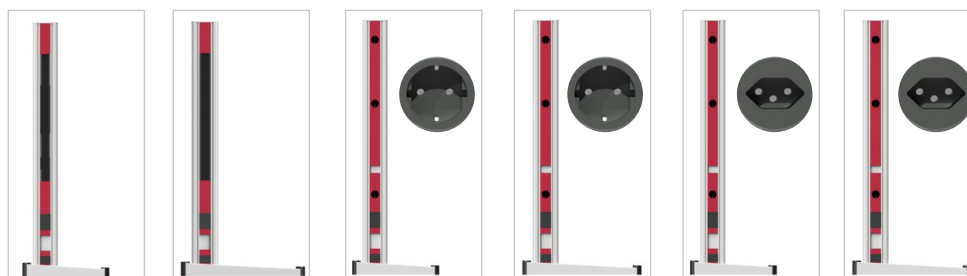

	basic equipment		with Schuko sockets		with Swiss sockets	
	short foot part	long foot part	short foot part	long foot part	short foot part	long foot part
H = 1000 mm	10.950.0_	10.951.0_	10.960.0_	10.961.0_	10.970.0_	10.971.0_
H = 1600 mm	10.952.0_	10.953.0_	10.962.0_	10.963.0_	10.972.0_	10.973.0_
H = 2200 mm	10.954.0_	10.955.0_	10.964.0_	10.965.0_	10.974.0_	10.975.0_

Equipment

3 m power cord with Schuko plug and WINSTA socket	95.625.98
3 m power cord with Swiss plug and WINSTA socket	95.627.98

Column extension



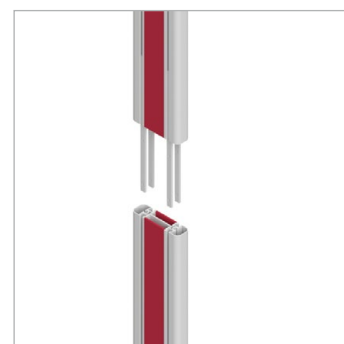

- for extending table columns
- incl. mounting kit for attaching to the QUADRO column
- H = 600 mm
- special dimensions on request

10.940.0_



Please add the color key for the decorative elements to the article number:

Decor color

	water blue (RAL 5021)	..._..._2
	cobalt blue (RAL 5013)	..._..._3
	raspberry red (RAL 3027)	..._..._4
	zinc yellow (RAL 1018)	..._..._6
	pigeon blue (RAL 5014)	..._..._8

Other colors for realizing your corporate identity on request

Table tops

**Table top thickness 40 mm
postformed edge**

- light gray table top (RAL 7035)
- Hard laminate (EN 438)
- table top depth: 880 mm
- with cutouts for QUADRO columns
- including mounting kit for mounting on the QUADRO columns

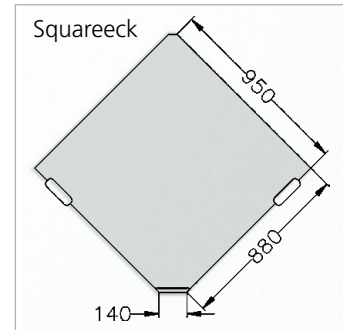
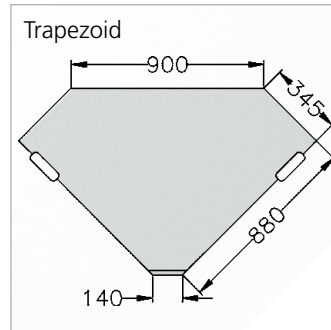

Standard

table width	basic equipment	incl. cable tray	incl. cable tray with flap
1300 mm	10.900.88	10.910.88	10.920.88
1650 mm	10.902.88	10.912.88	10.922.88
2135 mm	10.904.88	10.914.88	10.924.88
Trapezoid	10.906.88	10.916.88	
Squareeck	10.907.88	10.917.88	

ESD

table width	basic equipment	incl. cable tray	incl. cable tray with flap
1300 mm	10.900.89	10.910.89	10.920.89
1650 mm	10.902.89	10.912.89	10.922.89
2135 mm	10.904.89	10.914.89	10.924.89
Trapezoid	10.906.89	10.916.89	
Squareeck	10.907.89	10.917.89	

Additional table top on the side

- for laterally flush attachment of a QUADRO table to a row of tables
- incl. mounting kit for mounting on the QUADRO column
- W = 250 mm, D = 880 mm

	Standard	ESD
left	10.930.88	10.930.89
right	10.931.88	10.931.89



QUADRO twin 300

Manually height adjustable

- **Table height: height adjustment range 765 - 785 mm**
- 20 mm height adjustable
- load capacity: max. surface load 200 kg

Consisting of:

- frame
- set of pillars on the left
- set of pillars on the right
- table top

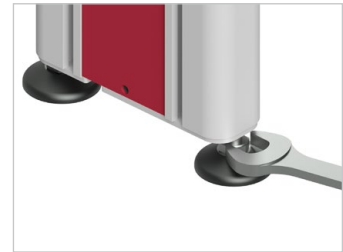
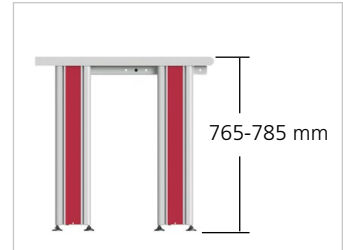
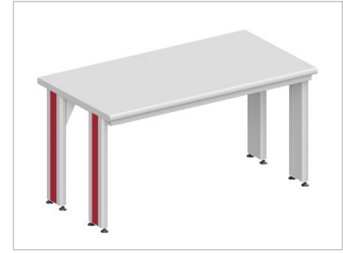

QUADRO twin 300

Framework

- steel frame for mounting the table top
- conductive powder-coated, light gray (RAL 7035)
- 4 different table widths
- 2 different table depths



Optional: in ESD design according to IEC 61340-5-1



- grounding box with two 10 mm push-button connections
- central earthing point for connecting the ESD or protective earth



Table depth: 800 mm

table width	1200 mm	1500 mm	1800 mm	2000 mm
Standard	301.1200.800.0	301.1500.800.0	301.1800.800.0	301.2000.800.0
ESD	301.1200.800.1	301.1500.800.1	301.1800.800.1	301.2000.800.1

Table depth: 1000 mm

table width	1200 mm	1500 mm	1800 mm	2000 mm
Standard	301.1200.1000.0	301.1500.1000.0	301.1800.1000.0	301.2000.1000.0
ESD	301.1200.1000.1	301.1500.1000.1	301.1800.1000.1	301.2000.1000.1

Columns

- QUADRO column made of aluminum as a functional and optical basic element
- manually height adjustable, 765 - 785 mm
- conductive powder-coated, light gray (RAL 7035)
- color accents with decorative elements in the pillars
- conductive height adjustment elements in the foot parts
- legroom with corner table combinations thanks to table legs that can be moved to the rear

Consisting of:

- basic pillar
- optional add-on column

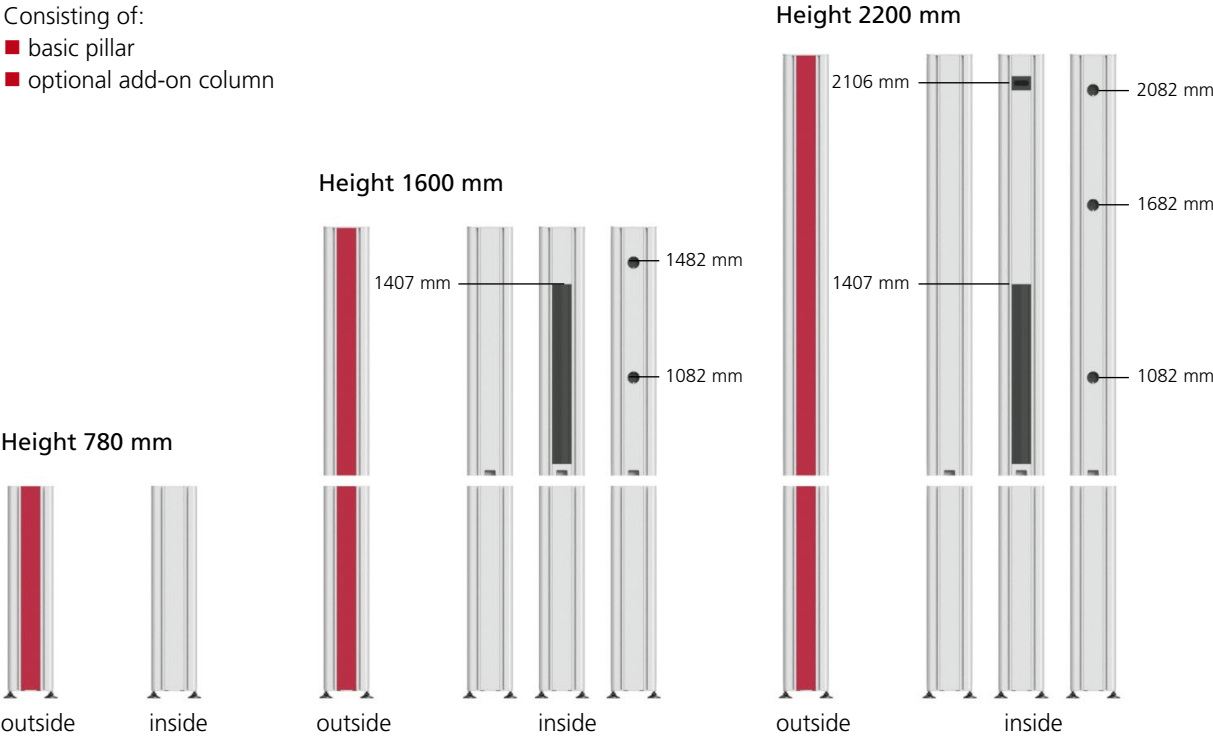

with decorative element	with brush element	with Schuko sockets	with Swiss sockets
-------------------------	--------------------	---------------------	--------------------

Energy, compressed air and data lines can be installed in the two cable ducts of the QUADRO columns be relocated.

Integrated brush strips e.g. for cable routing in connection with cable tray and / or 19" structure.

Integrated Schuko sockets on the inside e.g. for electrifying the upper shelves.

Integrated Swiss sockets on the inside e.g. to electrify the upper shelves.

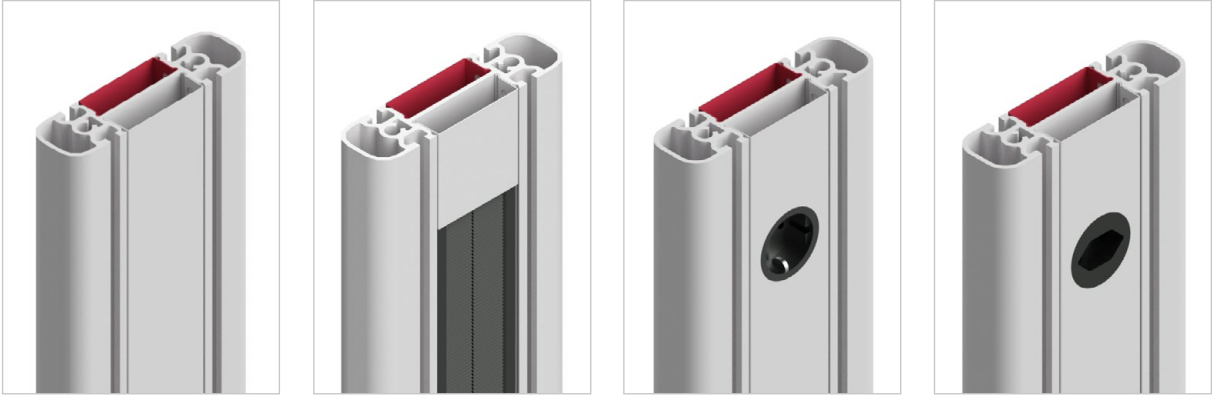

QUADRO twin 300

Set of pillars on the left

- QUADRO column made of aluminum as a functional and optical basic element
- manually height adjustable, 765 - 785 mm
- conductive powder-coated, light gray (RAL 7035)
- 3 different column heights

Optional:

- decorative element on the outside
- brush above the table top, on the inside
- sockets above the table top, on the inside
- prepared for table top including cable tray with flap for column height 780 mm / 1600 mm / 2200 mm









Set of pillars on the left

column height	780 / 780 mm	780 / 1600 mm	780 / 2200 mm
without decorative element	302.780.780.0.70	---	---
decorative element plug-in profile	302.780.780.5._ _	---	---
decorative element snap-in profile	302.780.780.1._ _	302.780.1600.1._ _	302.780.2200.1._ _
brush	---	302.780.1600.2._ _	302.780.2200.2._ _
socket D	---	302.780.1600.3._ _	302.780.2200.3._ _
socket CH	---	302.780.1600.4._ _	302.780.2200.4._ _

Set of pillars on the left - for table top including cable tray with flap

Tabletop thickness	27 mm	29 mm	40 mm
column height	780 / 780 mm	780 / 780 mm	780 / 780 mm
without decorative element	302.780.780.27.0.70	302.780.780.29.0.70	302.780.780.40.0.70
decorative element plug-in profile	302.780.780.27.5._ _	302.780.780.29.5._ _	302.780.780.40.5._ _
decorative element snap-in profile	302.780.780.27.1._ _	302.780.780.29.1._ _	302.780.780.40.1._ _

Please add the color key for the decorative elements to the article number:

	lichtgrau (RAL 7035)	__._._._.70
	water blue (RAL 5021)	__._._._.02
	cobalt blue (RAL 5013)	__._._._.03
	raspberry red (RAL 3027)	__._._._.04
	zinc yellow (RAL 1018)	__._._._.06
	pigeon blue (RAL 5014)	__._._._.08

Other colors for realizing your corporate identity on request

Set of pillars on the right

- QUADRO column made of aluminum as a functional and optical basic element
- manually height adjustable, 765 - 785 mm
- conductive powder-coated, light gray (RAL 7035)
- 3 different column heights

Optional:

- decorative element on the outside
- brush above the table top, on the inside
- sockets above the table top, on the inside
- prepared for table top including cable tray with flap for column height 780 mm / 1600 mm / 2200 mm









Set of pillars on the right

column height	780 / 780 mm	780 / 1600 mm	780 / 2200 mm
without decorative element	303.780.780.0.70	---	---
decorative element plug-in profile	303.780.780.5._ _	---	---
decorative element snap-in profile	303.780.780.1._ _	303.780.1600.1._ _	303.780.2200.1._ _
brush	---	303.780.1600.2._ _	303.780.2200.2._ _
socket D	---	303.780.1600.3._ _	303.780.2200.3._ _
socket CH	---	303.780.1600.4._ _	303.780.2200.4._ _

Set of pillars on the right - for table top including cable tray with flap

Tabletop thickness	27 mm	29 mm	40 mm
column height	780 / 780 mm	780 / 780 mm	780 / 780 mm
without decorative element	303.780.780.27.0.70	303.780.780.29.0.70	303.780.780.40.0.70
decorative element plug-in profile	303.780.780.27.5._ _	303.780.780.29.5._ _	303.780.780.40.5._ _
decorative element snap-in profile	303.780.780.27.1._ _	303.780.780.29.1._ _	303.780.780.40.1._ _

Please add the color key for the decorative elements to the article number:

	lichtgrau (RAL 7035)	___.70
	water blue (RAL 5021)	___.02
	cobalt blue (RAL 5013)	___.03
	raspberry red (RAL 3027)	___.04
	zinc yellow (RAL 1018)	___.06
	pigeon blue (RAL 5014)	___.08

Other colors for realizing your corporate identity on request

QUADRO twin 300

Table tops

- light gray table top (RAL 7035)
- protected with robust edge band
- slightly structured surface, glare-free and highly scratch-resistant
- briefly heat-resistant up to 180°C
- resistant to organic solvents, weak acids and alkalis, gasoline and oil

Standard:

- Hard laminate (EN 438)
- very hard and abrasion-resistant HPL laminate

ESD version:

- conductive ESD Hard laminate (EN 438)
- very hard and abrasion-resistant, conductive HPL laminate
- volume conductive carrier plate
- leak resistance 10^9 Ohm (dry measurement according to IEC 61340-5-1, 100 V)



Table top edges / thicknesses

- ABS edge (Acrylnitril-Butadien-Styrol) 27 mm
- Postforming edge 40 mm
- Postforming edge Premium 68/29 mm

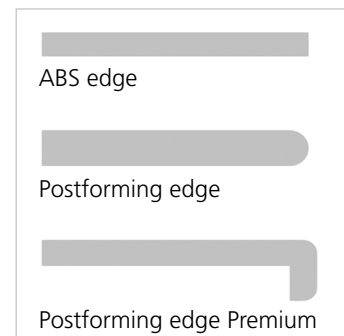

Table top including cable duct

- Ø 80 mm
- 2 recesses in the width of the table 1200 mm and 1500 mm
- 3 recesses in the width of the table 1800 mm and 2000 mm
- 3 recesses in the corner table top
- including cable entry sets



Table top including cable tray with flap

- cable tray integrated in the table top with hinged cover
- cable tray D = 200 mm
- cover divided in the middle for table width 1800 mm und 2000 mm
- with brush strip for cable entry when the cover is closed

Optional:

- Electrical insert strip, prepared for individual assembly with insert plates (page 107)
 - table width 1200 mm: 900 mm usable width for insert panels
 - table width 1500 mm: 1200 mm usable width for insert panels
 - table width 1800 mm: 1500 mm usable width for insert panels
 - table width 2000 mm: 1700 mm usable width for insert panels



Table top for column height 780 mm

Table top thickness 27 mm ABS edge

- light gray table top (RAL 7035)
- Hard laminate (EN 438)

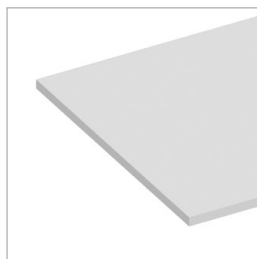

Table depth 800 mm

table width	1200 mm	1500 mm
Standard	304.1200.800.27.0.0	304.1500.800.27.0.0
Standard, ESD	304.1200.800.27.0.1	304.1500.800.27.0.1
incl. cable entry	304.1200.800.27.1.0	304.1500.800.27.1.0
incl. cable entry, ESD	304.1200.800.27.1.1	304.1500.800.27.1.1
incl. cable tray with flap	304.1200.800.27.2.0	304.1500.800.27.2.0
incl. cable tray with flap, ESD	304.1200.800.27.2.1	304.1500.800.27.2.1

table width	1800 mm	2000 mm
Standard	304.1800.800.27.0.0	304.2000.800.27.0.0
Standard, ESD	304.1800.800.27.0.1	304.2000.800.27.0.1
incl. cable entry	304.1800.800.27.1.0	304.2000.800.27.1.0
incl. cable entry, ESD	304.1800.800.27.1.1	304.2000.800.27.1.1
incl. cable tray with flap	304.1800.800.27.2.0	304.2000.800.27.2.0
incl. cable tray with flap, ESD	304.1800.800.27.2.1	304.2000.800.27.2.1

Table depth 1000 mm

table width	1200 mm	1500 mm
Standard	304.1200.1000.27.0.0	304.1500.1000.27.0.0
Standard, ESD	304.1200.1000.27.0.1	304.1500.1000.27.0.1
incl. cable entry	304.1200.1000.27.1.0	304.1500.1000.27.1.0
incl. cable entry, ESD	304.1200.1000.27.1.1	304.1500.1000.27.1.1
incl. cable tray with flap	304.1200.1000.27.2.0	304.1500.1000.27.2.0
incl. cable tray with flap, ESD	304.1200.1000.27.2.1	304.1500.1000.27.2.1

table width	1800 mm	2000 mm
Standard	304.1800.1000.27.0.0	304.2000.1000.27.0.0
Standard, ESD	304.1800.1000.27.0.1	304.2000.1000.27.0.1
incl. cable entry	304.1800.1000.27.1.0	304.2000.1000.27.1.0
incl. cable entry, ESD	304.1800.1000.27.1.1	304.2000.1000.27.1.1
incl. cable tray with flap	304.1800.1000.27.2.0	304.2000.1000.27.2.0
incl. cable tray with flap, ESD	304.1800.1000.27.2.1	304.2000.1000.27.2.1

Table top for column height 780 mm

Table top thickness 40 mm postformed edge

- light gray table top (RAL 7035)
- Hard laminate (EN 438)

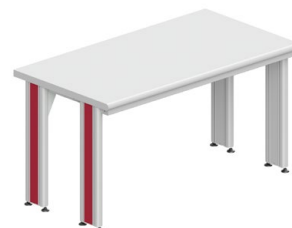
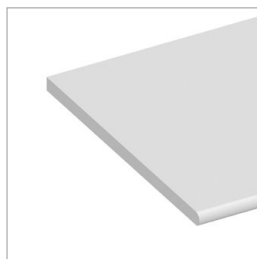

Table depth 800 mm

table width	1200 mm	1500 mm
Standard	304.1200.800.40.0.0	304.1500.800.40.0.0
Standard, ESD	304.1200.800.40.0.1	304.1500.800.40.0.1
incl. cable entry	304.1200.800.40.1.0	304.1500.800.40.1.0
incl. cable entry, ESD	304.1200.800.40.1.1	304.1500.800.40.1.1
incl. cable tray with flap	304.1200.800.40.2.0	304.1500.800.40.2.0
incl. cable tray with flap, ESD	304.1200.800.40.2.1	304.1500.800.40.2.1

table width	1800 mm	2000 mm
Standard	304.1800.800.40.0.0	304.2000.800.40.0.0
Standard, ESD	304.1800.800.40.0.1	304.2000.800.40.0.1
incl. cable entry	304.1800.800.40.1.0	304.2000.800.40.1.0
incl. cable entry, ESD	304.1800.800.40.1.1	304.2000.800.40.1.1
incl. cable tray with flap	304.1800.800.40.2.0	304.2000.800.40.2.0
incl. cable tray with flap, ESD	304.1800.800.40.2.1	304.2000.800.40.2.1

Table depth 1000 mm

table width	1200 mm	1500 mm
Standard	304.1200.1000.40.0.0	304.1500.1000.40.0.0
Standard, ESD	304.1200.1000.40.0.1	304.1500.1000.40.0.1
incl. cable entry	304.1200.1000.40.1.0	304.1500.1000.40.1.0
incl. cable entry, ESD	304.1200.1000.40.1.1	304.1500.1000.40.1.1
incl. cable tray with flap	304.1200.1000.40.2.0	304.1500.1000.40.2.0
incl. cable tray with flap, ESD	304.1200.1000.40.2.1	304.1500.1000.40.2.1

table width	1800 mm	2000 mm
Standard	304.1800.1000.40.0.0	304.2000.1000.40.0.0
Standard, ESD	304.1800.1000.40.0.1	304.2000.1000.40.0.1
incl. cable entry	304.1800.1000.40.1.0	304.2000.1000.40.1.0
incl. cable entry, ESD	304.1800.1000.40.1.1	304.2000.1000.40.1.1
incl. cable tray with flap	304.1800.1000.40.2.0	304.2000.1000.40.2.0
incl. cable tray with flap, ESD	304.1800.1000.40.2.1	304.2000.1000.40.2.1

Table top for column height 780 mm

Table top thickness 68/29 mm Postforming edge Premium

- light gray table top (RAL 7035)
- Hard laminate (EN 438)

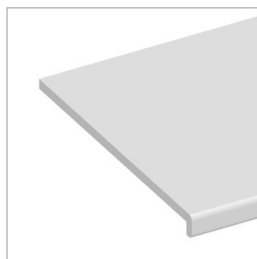

Table depth 800 mm

table width	1200 mm	1500 mm
Standard	304.1200.800.29.0.0	304.1500.800.29.0.0
Standard, ESD	304.1200.800.29.0.1	304.1500.800.29.0.1
incl. cable entry	304.1200.800.29.1.0	304.1500.800.29.1.0
incl. cable entry, ESD	304.1200.800.29.1.1	304.1500.800.29.1.1
incl. cable tray with flap	304.1200.800.29.2.0	304.1500.800.29.2.0
incl. cable tray with flap, ESD	304.1200.800.29.2.1	304.1500.800.29.2.1

table width	1800 mm	2000 mm
Standard	304.1800.800.29.0.0	304.2000.800.29.0.0
Standard, ESD	304.1800.800.29.0.1	304.2000.800.29.0.1
incl. cable entry	304.1800.800.29.1.0	304.2000.800.29.1.0
incl. cable entry, ESD	304.1800.800.29.1.1	304.2000.800.29.1.1
incl. cable tray with flap	304.1800.800.29.2.0	304.2000.800.29.2.0
incl. cable tray with flap, ESD	304.1800.800.29.2.1	304.2000.800.29.2.1

Table depth 1000 mm

table width	1200 mm	1500 mm
Standard	304.1200.1000.29.0.0	304.1500.1000.29.0.0
Standard, ESD	304.1200.1000.29.0.1	304.1500.1000.29.0.1
incl. cable entry	304.1200.1000.29.1.0	304.1500.1000.29.1.0
incl. cable entry, ESD	304.1200.1000.29.1.1	304.1500.1000.29.1.1
incl. cable tray with flap	304.1200.1000.29.2.0	304.1500.1000.29.2.0
incl. cable tray with flap, ESD	304.1200.1000.29.2.1	304.1500.1000.29.2.1

table width	1800 mm	2000 mm
Standard	304.1800.1000.29.0.0	304.2000.1000.29.0.0
Standard, ESD	304.1800.1000.29.0.1	304.2000.1000.29.0.1
incl. cable entry	304.1800.1000.29.1.0	304.2000.1000.29.1.0
incl. cable entry, ESD	304.1800.1000.29.1.1	304.2000.1000.29.1.1
incl. cable tray with flap	304.1800.1000.29.2.0	304.2000.1000.29.2.0
incl. cable tray with flap, ESD	304.1800.1000.29.2.1	304.2000.1000.29.2.1

Table top for column height 1600 / 2200 mm

Table top thickness 27 mm ABS edge

- light gray table top (RAL 7035)
- Hard laminate (EN 438)
- with cutouts for QUADRO columns

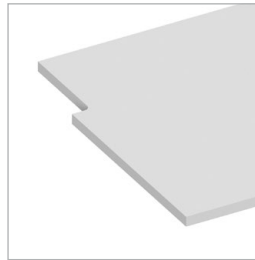

Table depth 800 mm

table width	1200 mm	1500 mm
Standard	304.1200.800.27.3.0	304.1500.800.27.3.0
Standard, ESD	304.1200.800.27.3.1	304.1500.800.27.3.1
incl. cable entry	304.1200.800.27.4.0	304.1500.800.27.4.0
incl. cable entry, ESD	304.1200.800.27.4.1	304.1500.800.27.4.1
incl. cable tray with flap	304.1200.800.27.5.0	304.1500.800.27.5.0
incl. cable tray with flap, ESD	304.1200.800.27.5.1	304.1500.800.27.5.1

table width	1800 mm	2000 mm
Standard	304.1800.800.27.3.0	304.2000.800.27.3.0
Standard, ESD	304.1800.800.27.3.1	304.2000.800.27.3.1
incl. cable entry	304.1800.800.27.4.0	304.2000.800.27.4.0
incl. cable entry, ESD	304.1800.800.27.4.1	304.2000.800.27.4.1
incl. cable tray with flap	304.1800.800.27.5.0	304.2000.800.27.5.0
incl. cable tray with flap, ESD	304.1800.800.27.5.1	304.2000.800.27.5.1

Table depth 1000 mm

table width	1200 mm	1500 mm
Standard	304.1200.1000.27.3.0	304.1500.1000.27.3.0
Standard, ESD	304.1200.1000.27.3.1	304.1500.1000.27.3.1
incl. cable entry	304.1200.1000.27.4.0	304.1500.1000.27.4.0
incl. cable entry, ESD	304.1200.1000.27.4.1	304.1500.1000.27.4.1
incl. cable tray with flap	304.1200.1000.27.5.0	304.1500.1000.27.5.0
incl. cable tray with flap, ESD	304.1200.1000.27.5.1	304.1500.1000.27.5.1

table width	1800 mm	2000 mm
Standard	304.1800.1000.27.3.0	304.2000.1000.27.3.0
Standard, ESD	304.1800.1000.27.3.1	304.2000.1000.27.3.1
incl. cable entry	304.1800.1000.27.4.0	304.2000.1000.27.4.0
incl. cable entry, ESD	304.1800.1000.27.4.1	304.2000.1000.27.4.1
incl. cable tray with flap	304.1800.1000.27.5.0	304.2000.1000.27.5.0
incl. cable tray with flap, ESD	304.1800.1000.27.5.1	304.2000.1000.27.5.1

Table top for column height 1600 / 2200 mm

Table top thickness 40 mm postformed edge

- light gray table top (RAL 7035)
- Hard laminate (EN 438)
- with cutouts for QUADRO columns

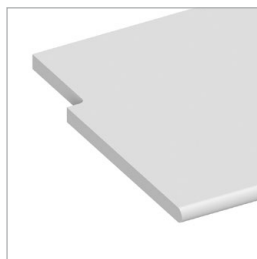

Table depth 800 mm

table width	1200 mm	1500 mm
Standard	304.1200.800.40.3.0	304.1500.800.40.3.0
Standard, ESD	304.1200.800.40.3.1	304.1500.800.40.3.1
incl. cable entry	304.1200.800.40.4.0	304.1500.800.40.4.0
incl. cable entry, ESD	304.1200.800.40.4.1	304.1500.800.40.4.1
incl. cable tray with flap	304.1200.800.40.5.0	304.1500.800.40.5.0
incl. cable tray with flap, ESD	304.1200.800.40.5.1	304.1500.800.40.5.1

table width	1800 mm	2000 mm
Standard	304.1800.800.40.3.0	304.2000.800.40.3.0
Standard, ESD	304.1800.800.40.3.1	304.2000.800.40.3.1
incl. cable entry	304.1800.800.40.4.0	304.2000.800.40.4.0
incl. cable entry, ESD	304.1800.800.40.4.1	304.2000.800.40.4.1
incl. cable tray with flap	304.1800.800.40.5.0	304.2000.800.40.5.0
incl. cable tray with flap, ESD	304.1800.800.40.5.1	304.2000.800.40.5.1

Table depth 1000 mm

table width	1200 mm	1500 mm
Standard	304.1200.1000.40.3.0	304.1500.1000.40.3.0
Standard, ESD	304.1200.1000.40.3.1	304.1500.1000.40.3.1
incl. cable entry	304.1200.1000.40.4.0	304.1500.1000.40.4.0
incl. cable entry, ESD	304.1200.1000.40.4.1	304.1500.1000.40.4.1
incl. cable tray with flap	304.1200.1000.40.5.0	304.1500.1000.40.5.0
incl. cable tray with flap, ESD	304.1200.1000.40.5.1	304.1500.1000.40.5.1

table width	1800 mm	2000 mm
Standard	304.1800.1000.40.3.0	304.2000.1000.40.3.0
Standard, ESD	304.1800.1000.40.3.1	304.2000.1000.40.3.1
incl. cable entry	304.1800.1000.40.4.0	304.2000.1000.40.4.0
incl. cable entry, ESD	304.1800.1000.40.4.1	304.2000.1000.40.4.1
incl. cable tray with flap	304.1800.1000.40.5.0	304.2000.1000.40.5.0
incl. cable tray with flap, ESD	304.1800.1000.40.5.1	304.2000.1000.40.5.1

Table top for column height 1600 / 2200 mm

Table top thickness 68/29 mm Postforming edge Premium

- light gray table top (RAL 7035)
- Hard laminate (EN 438)
- with cutouts for QUADRO columns



Table depth 800 mm

table width	1200 mm	1500 mm
Standard	304.1200.800.29.3.0	304.1500.800.29.3.0
Standard, ESD	304.1200.800.29.3.1	304.1500.800.29.3.1
incl. cable entry	304.1200.800.29.4.0	304.1500.800.29.4.0
incl. cable entry, ESD	304.1200.800.29.4.1	304.1500.800.29.4.1
incl. cable tray with flap	304.1200.800.29.5.0	304.1500.800.29.5.0
incl. cable tray with flap, ESD	304.1200.800.29.5.1	304.1500.800.29.5.1

table width	1800 mm	2000 mm
Standard	304.1800.800.29.3.0	304.2000.800.29.3.0
Standard, ESD	304.1800.800.29.3.1	304.2000.800.29.3.1
incl. cable entry	304.1800.800.29.4.0	304.2000.800.29.4.0
incl. cable entry, ESD	304.1800.800.29.4.1	304.2000.800.29.4.1
incl. cable tray with flap	304.1800.800.29.5.0	304.2000.800.29.5.0
incl. cable tray with flap, ESD	304.1800.800.29.5.1	304.2000.800.29.5.1

Table depth 1000 mm

table width	1200 mm	1500 mm
Standard	304.1200.1000.29.3.0	304.1500.1000.29.3.0
Standard, ESD	304.1200.1000.29.3.1	304.1500.1000.29.3.1
incl. cable entry	304.1200.1000.29.4.0	304.1500.1000.29.4.0
incl. cable entry, ESD	304.1200.1000.29.4.1	304.1500.1000.29.4.1
incl. cable tray with flap	304.1200.1000.29.5.0	304.1500.1000.29.5.0
incl. cable tray with flap, ESD	304.1200.1000.29.5.1	304.1500.1000.29.5.1

table width	1800 mm	2000 mm
Standard	304.1800.1000.29.3.0	304.2000.1000.29.3.0
Standard, ESD	304.1800.1000.29.3.1	304.2000.1000.29.3.1
incl. cable entry	304.1800.1000.29.4.0	304.2000.1000.29.4.0
incl. cable entry, ESD	304.1800.1000.29.4.1	304.2000.1000.29.4.1
incl. cable tray with flap	304.1800.1000.29.5.0	304.2000.1000.29.5.0
incl. cable tray with flap, ESD	304.1800.1000.29.5.1	304.2000.1000.29.5.1

Corner tabletops

Trapezoid

- light gray table top (RAL 7035)
- Hard laminate (EN 438)
- including mounting kit for mounting on the QUADRO columns

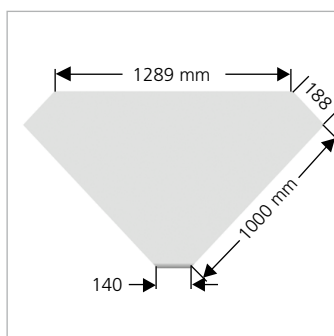
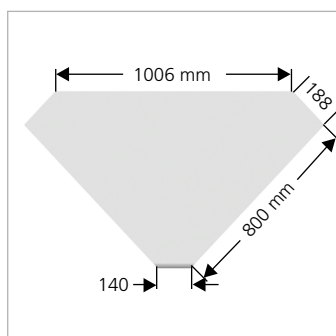

Table top thickness 27 mm ABS edge

table depth	800 mm	1000 mm
Standard	305.800.800.27.0.0	305.1000.1000.27.0.0
Standard, ESD	305.800.800.27.0.1	305.1000.1000.27.0.1
incl. cable entry	305.800.800.27.1.0	305.1000.1000.27.1.0
incl. cable entry, ESD	305.800.800.27.1.1	305.1000.1000.27.1.1

Table top thickness 40 mm Postforming edge

table depth	800 mm	1000 mm
Standard	305.800.800.40.0.0	305.1000.1000.40.0.0
Standard, ESD	305.800.800.40.0.1	305.1000.1000.40.0.1
incl. cable entry	305.800.800.40.1.0	305.1000.1000.40.1.0
incl. cable entry, ESD	305.800.800.40.1.1	305.1000.1000.40.1.1

Table top thickness 68/29 mm Postforming edge Premium

table depth	800 mm	1000 mm
Standard	305.800.800.29.0.0	305.1000.1000.29.0.0
Standard, ESD	305.800.800.29.0.1	305.1000.1000.29.0.1
incl. cable entry	305.800.800.29.1.0	305.1000.1000.29.1.0
incl. cable entry, ESD	305.800.800.29.1.1	305.1000.1000.29.1.1

QUADRO twin 300

Square

- light gray table top (RAL 7035)
- Hard laminate (EN 438)
- including mounting kit for mounting on the QUADRO columns
- including height-adjustable table leg

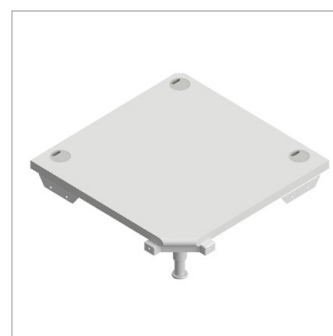
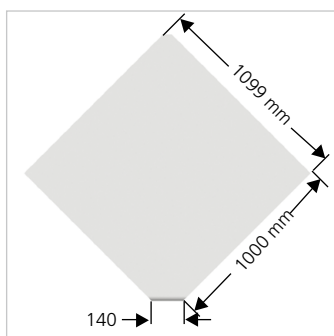
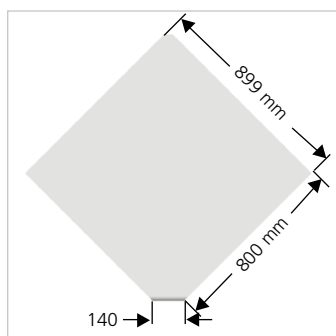

Table top thickness 27 mm ABS edge

table depth	800 mm	1000 mm
Standard	306.800.800.27.0.0	306.1000.1000.27.0.0
Standard, ESD	306.800.800.27.0.1	306.1000.1000.27.0.1
incl. cable entry	306.800.800.27.1.0	306.1000.1000.27.1.0
incl. cable entry, ESD	306.800.800.27.1.1	306.1000.1000.27.1.1

Table top thickness 40 mm postformed edge

table depth	800 mm	1000 mm
Standard	306.800.800.40.0.0	306.1000.1000.40.0.0
Standard, ESD	306.800.800.40.0.1	306.1000.1000.40.0.1
incl. cable entry	306.800.800.40.1.0	306.1000.1000.40.1.0
incl. cable entry, ESD	306.800.800.40.1.1	306.1000.1000.40.1.1

Table top thickness 68/29 mm Postforming edge Premium

table depth	800 mm	1000 mm
Standard	306.800.800.29.0.0	306.1000.1000.29.0.0
Standard, ESD	306.800.800.29.0.1	306.1000.1000.29.0.1
incl. cable entry	306.800.800.29.1.0	306.1000.1000.29.1.0
incl. cable entry, ESD	306.800.800.29.1.1	306.1000.1000.29.1.1

QUADRO twin 400

Manually height adjustable with adjustable foot

- **Table height: height adjustment range 735 - 835 mm**
- 100 mm height adjustable
- load capacity: max. surface load 200 kg

Consisting of:

- frame
- set of pillars on the left
- set of pillars on the right
- table top

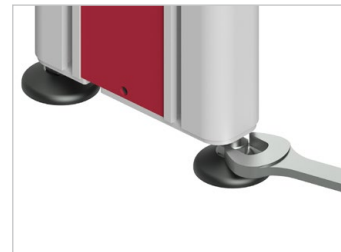
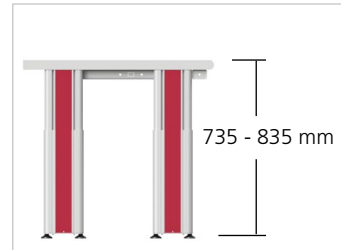
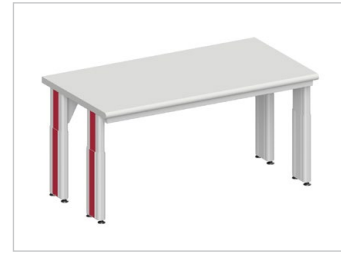

QUADRO twin 400

Framework

- steel frame for mounting the table top
- conductive powder-coated, light gray (RAL 7035)
- 4 different table widths
- 2 different table depths



Optional: in ESD design according to IEC 61340-5-1



- grounding box with two 10 mm push-button connections
- central earthing point for connecting the ESD or protective earth



Table depth: 800 mm

table width	1200 mm	1500 mm	1800 mm	2000 mm
Standard	401.1200.800.0	401.1500.800.0	401.1800.800.0	401.2000.800.0
ESD	401.1200.800.1	401.1500.800.1	401.1800.800.1	401.2000.800.1

Table depth: 1000 mm

table width	1200 mm	1500 mm	1800 mm	2000 mm
Standard	401.1200.1000.0	401.1500.1000.0	401.1800.1000.0	401.2000.1000.0
ESD	401.1200.1000.1	401.1500.1000.1	401.1800.1000.1	401.2000.1000.1

Columns

- QUADRO column made of aluminum as a functional and optical basic element
- manually height adjustable, 735 - 835 mm
- conductive powder-coated, light gray (RAL 7035)
- color accents with decorative elements in the pillars
- conductive height adjustment elements in the foot parts
- legroom with corner table combinations thanks to table legs that can be moved to the rear

Consisting of:

- basic pillar
- foot part
- optional add-on column

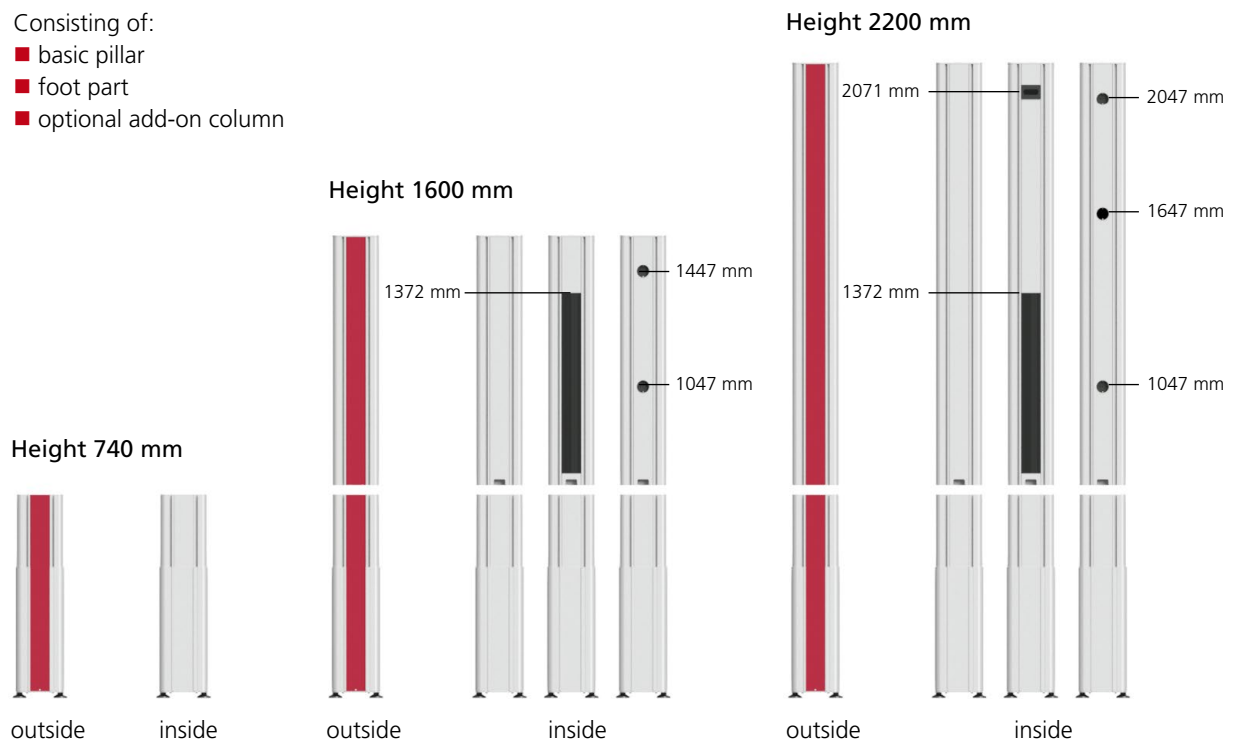

with decorative element	with brush element	with Schuko sockets	with Swiss sockets
-------------------------	--------------------	---------------------	--------------------

Energy, compressed air and data lines can be installed in the two cable ducts of the QUADRO columns be relocated.

Integrated brush strips e.g. for cable routing in connection with cable tray and / or 19" structure.

Integrated Schuko sockets on the inside e.g. for electrifying the upper shelves.

Integrated Swiss sockets on the inside e.g. to electrify the upper shelves.

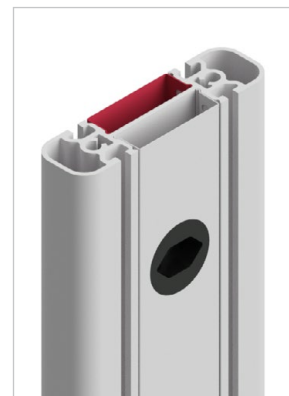
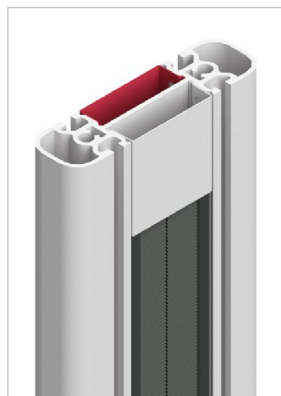
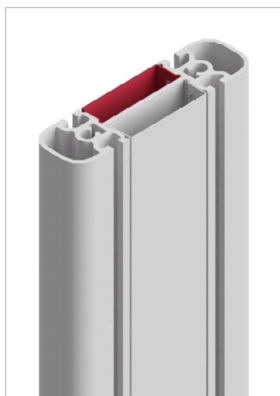

Set of pillars on the left

- QUADRO column made of aluminum as a functional and optical basic element
- manually height adjustable, 735 - 835 mm
- conductive powder-coated, light gray (RAL 7035)
- 3 different column heights

Optional:

- decorative element on the outside
- brush above the table top, on the inside
- sockets above the table top, on the inside
- prepared for table top including cable tray with flap for column height 780 mm / 1600 mm / 2200 mm









Set of pillars on the left

column height	740 / 740 mm	740 / 1600 mm	740 / 2200 mm
without decorative element	---	---	---
decorative element plug-in profile	---	---	---
decorative element snap-in profile	402.740.740.1._ _	402.740.1600.1._ _	402.740.2200.1._ _
brush	---	402.740.1600.2._ _	402.740.2200.2._ _
socket D	---	402.740.1600.3._ _	402.740.2200.3._ _
socket CH	---	402.740.1600.4._ _	402.740.2200.4._ _

Set of pillars on the left - for table top including cable tray with flap

Tabletop thickness	27 mm	29 mm	40 mm
column height	740 / 740 mm	740 / 740 mm	740 / 740 mm
without decorative element	---	---	---
decorative element plug-in profile	---	---	---
decorative element snap-in profile	402.740.740.27.1._ _	402.740.740.29.1._ _	402.740.740.40.1._ _

Please add the color key for the decorative elements to the article number:

	lichtgrau (RAL 7035)	___.70
	water blue (RAL 5021)	___.02
	cobalt blue (RAL 5013)	___.03
	raspberry red (RAL 3027)	___.04
	zinc yellow (RAL 1018)	___.06
	pigeon blue (RAL 5014)	___.08

Other colors for realizing your corporate identity on request

Set of pillars on the right

- QUADRO column made of aluminum as a functional and optical basic element
- manually height adjustable, 735 - 835 mm
- conductive powder-coated, light gray (RAL 7035)
- 3 different column heights

Optional:

- decorative element on the outside
- brush above the table top, on the inside
- sockets above the table top, on the inside
- prepared for table top including cable tray with flap for column height 780 mm / 1600 mm / 2200 mm









Set of pillars on the right

column height	740 / 740 mm	740 / 1600 mm	740 / 2200 mm
without decorative element	---	---	---
decorative element plug-in profile	---	---	---
decorative element snap-in profile	403.740.740.1._ _	403.740.1600.1._ _	403.740.2200.1._ _
brush	---	403.740.1600.2._ _	403.740.2200.2._ _
socket D	---	403.740.1600.3._ _	403.740.2200.3._ _
socket CH	---	403.740.1600.4._ _	403.740.2200.4._ _

Set of pillars on the right - for table top including cable tray with flap

Tabletop thickness	27 mm	29 mm	40 mm
column height	740 / 740 mm	740 / 740 mm	740 / 740 mm
without decorative element	---	---	---
decorative element plug-in profile	---	---	---
decorative element snap-in profile	403.740.740.27.1._ _	403.740.740.29.1._ _	403.740.740.40.1._ _

Please add the color key for the decorative elements to the article number:

	lichtgrau (RAL 7035)	__._._._.70
	water blue (RAL 5021)	__._._._.02
	cobalt blue (RAL 5013)	__._._._.03
	raspberry red (RAL 3027)	__._._._.04
	zinc yellow (RAL 1018)	__._._._.06
	pigeon blue (RAL 5014)	__._._._.08

Other colors for realizing your corporate identity on request

QUADRO twin 400

Table tops

- light gray table top (RAL 7035)
- protected with robust edge band
- slightly structured surface, glare-free and highly scratch-resistant
- briefly heat-resistant up to 180°C
- resistant to organic solvents, weak acids and alkalis, gasoline and oil

Standard:

- Hard laminate (EN 438)
- very hard and abrasion-resistant HPL laminate

ESD version:

- conductive ESD Hard laminate (EN 438)
- very hard and abrasion-resistant, conductive HPL laminate
- volume conductive carrier plate
- leakage resistance $< 10^9$ Ohm (dry measurement according to nach IEC 61340-5-1, 100 V)



Table top edges / thicknesses

- ABS edge (Acrylnitril-Butadien-Styrol) 27 mm
- Postforming edge 40 mm
- Postforming edge Premium 68/29 mm

ABS edge

Postforming edge

Postforming edge Premium

Table top including cable duct

- Ø 80 mm
- 2 recesses in the width of the table 1200 mm and 1500 mm
- 3 recesses in the width of the table 1800 mm and 2000 mm
- 3 recesses in the corner table top
- including cable entry sets



Table top including cable tray with flap

- cable tray integrated in the table top with hinged cover
- cable tray D = 200 mm
- cover divided in the middle for table width 1800 mm und 2000 mm
- with brush strip for cable entry when the cover is closed

Optional:

- Electrical insert strip, prepared for individual assembly with insert plates (page 107)
 - table width 1200 mm: 900 mm usable width for insert panels
 - table width 1500 mm: 1200 mm usable width for insert panels
 - table width 1800 mm: 1500 mm usable width for insert panels
 - table width 2000 mm: 1700 mm usable width for insert panels



Table top for column height 740 mm

Table top thickness 27 mm ABS edge

- light gray table top (RAL 7035)
- Hard laminate (EN 438)

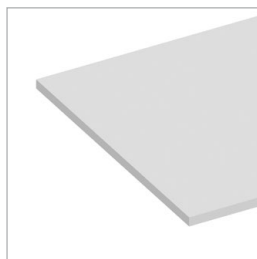

Table depth 800 mm

table width	1200 mm	1500 mm
Standard	404.1200.800.27.0.0	404.1500.800.27.0.0
Standard, ESD	404.1200.800.27.0.1	404.1500.800.27.0.1
incl. cable entry	404.1200.800.27.1.0	404.1500.800.27.1.0
incl. cable entry, ESD	404.1200.800.27.1.1	404.1500.800.27.1.1
incl. cable tray with flap	404.1200.800.27.2.0	404.1500.800.27.2.0
incl. cable tray with flap, ESD	404.1200.800.27.2.1	404.1500.800.27.2.1

table width	1800 mm	2000 mm
Standard	404.1800.800.27.0.0	404.2000.800.27.0.0
Standard, ESD	404.1800.800.27.0.1	404.2000.800.27.0.1
incl. cable entry	404.1800.800.27.1.0	404.2000.800.27.1.0
incl. cable entry, ESD	404.1800.800.27.1.1	404.2000.800.27.1.1
incl. cable tray with flap	404.1800.800.27.2.0	404.2000.800.27.2.0
incl. cable tray with flap, ESD	404.1800.800.27.2.1	404.2000.800.27.2.1

Table depth 1000 mm

table width	1200 mm	1500 mm
Standard	404.1200.1000.27.0.0	404.1500.1000.27.0.0
Standard, ESD	404.1200.1000.27.0.1	404.1500.1000.27.0.1
incl. cable entry	404.1200.1000.27.1.0	404.1500.1000.27.1.0
incl. cable entry, ESD	404.1200.1000.27.1.1	404.1500.1000.27.1.1
incl. cable tray with flap	404.1200.1000.27.2.0	404.1500.1000.27.2.0
incl. cable tray with flap, ESD	404.1200.1000.27.2.1	404.1500.1000.27.2.1

table width	1800 mm	2000 mm
Standard	404.1800.1000.27.0.0	404.2000.1000.27.0.0
Standard, ESD	404.1800.1000.27.0.1	404.2000.1000.27.0.1
incl. cable entry	404.1800.1000.27.1.0	404.2000.1000.27.1.0
incl. cable entry, ESD	404.1800.1000.27.1.1	404.2000.1000.27.1.1
incl. cable tray with flap	404.1800.1000.27.2.0	404.2000.1000.27.2.0
incl. cable tray with flap, ESD	404.1800.1000.27.2.1	404.2000.1000.27.2.1

Table top for column height 740 mm

Table top thickness 40 mm postformed edge

- light gray table top (RAL 7035)
- Hard laminate (EN 438)

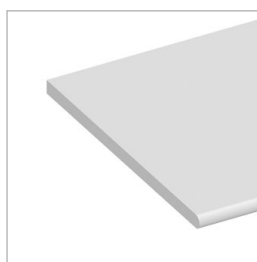

Table depth 800 mm

table width	1200 mm	1500 mm
Standard	404.1200.800.40.0.0	404.1500.800.40.0.0
Standard, ESD	404.1200.800.40.0.1	404.1500.800.40.0.1
incl. cable entry	404.1200.800.40.1.0	404.1500.800.40.1.0
incl. cable entry, ESD	404.1200.800.40.1.1	404.1500.800.40.1.1
incl. cable tray with flap	404.1200.800.40.2.0	404.1500.800.40.2.0
incl. cable tray with flap, ESD	404.1200.800.40.2.1	404.1500.800.40.2.1

table width	1800 mm	2000 mm
Standard	404.1800.800.40.0.0	404.2000.800.40.0.0
Standard, ESD	404.1800.800.40.0.1	404.2000.800.40.0.1
incl. cable entry	404.1800.800.40.1.0	404.2000.800.40.1.0
incl. cable entry, ESD	404.1800.800.40.1.1	404.2000.800.40.1.1
incl. cable tray with flap	404.1800.800.40.2.0	404.2000.800.40.2.0
incl. cable tray with flap, ESD	404.1800.800.40.2.1	404.2000.800.40.2.1

Table depth 1000 mm

table width	1200 mm	1500 mm
Standard	404.1200.1000.40.0.0	404.1500.1000.40.0.0
Standard, ESD	404.1200.1000.40.0.1	404.1500.1000.40.0.1
incl. cable entry	404.1200.1000.40.1.0	404.1500.1000.40.1.0
incl. cable entry, ESD	404.1200.1000.40.1.1	404.1500.1000.40.1.1
incl. cable tray with flap	404.1200.1000.40.2.0	404.1500.1000.40.2.0
incl. cable tray with flap, ESD	404.1200.1000.40.2.1	404.1500.1000.40.2.1

table width	1800 mm	2000 mm
Standard	404.1800.1000.40.0.0	404.2000.1000.40.0.0
Standard, ESD	404.1800.1000.40.0.1	404.2000.1000.40.0.1
incl. cable entry	404.1800.1000.40.1.0	404.2000.1000.40.1.0
incl. cable entry, ESD	404.1800.1000.40.1.1	404.2000.1000.40.1.1
incl. cable tray with flap	404.1800.1000.40.2.0	404.2000.1000.40.2.0
incl. cable tray with flap, ESD	404.1800.1000.40.2.1	404.2000.1000.40.2.1

Table top for column height 740 mm

Table top thickness 68/29 mm Postforming edge Premium

- light gray table top (RAL 7035)
- Hard laminate (EN 438)

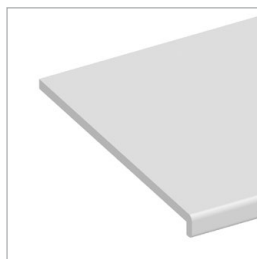

Table depth 800 mm

table width	1200 mm	1500 mm
Standard	404.1200.800.29.0.0	404.1500.800.29.0.0
Standard, ESD	404.1200.800.29.0.1	404.1500.800.29.0.1
incl. cable entry	404.1200.800.29.1.0	404.1500.800.29.1.0
incl. cable entry, ESD	404.1200.800.29.1.1	404.1500.800.29.1.1
incl. cable tray with flap	404.1200.800.29.2.0	404.1500.800.29.2.0
incl. cable tray with flap, ESD	404.1200.800.29.2.1	404.1500.800.29.2.1

table width	1800 mm	2000 mm
Standard	404.1800.800.29.0.0	404.2000.800.29.0.0
Standard, ESD	404.1800.800.29.0.1	404.2000.800.29.0.1
incl. cable entry	404.1800.800.29.1.0	404.2000.800.29.1.0
incl. cable entry, ESD	404.1800.800.29.1.1	404.2000.800.29.1.1
incl. cable tray with flap	404.1800.800.29.2.0	404.2000.800.29.2.0
incl. cable tray with flap, ESD	404.1800.800.29.2.1	404.2000.800.29.2.1

Table depth 1000 mm

table width	1200 mm	1500 mm
Standard	404.1200.1000.29.0.0	404.1500.1000.29.0.0
Standard, ESD	404.1200.1000.29.0.1	404.1500.1000.29.0.1
incl. cable entry	404.1200.1000.29.1.0	404.1500.1000.29.1.0
incl. cable entry, ESD	404.1200.1000.29.1.1	404.1500.1000.29.1.1
incl. cable tray with flap	404.1200.1000.29.2.0	404.1500.1000.29.2.0
incl. cable tray with flap, ESD	404.1200.1000.29.2.1	404.1500.1000.29.2.1

table width	1800 mm	2000 mm
Standard	404.1800.1000.29.0.0	404.2000.1000.29.0.0
Standard, ESD	404.1800.1000.29.0.1	404.2000.1000.29.0.1
incl. cable entry	404.1800.1000.29.1.0	404.2000.1000.29.1.0
incl. cable entry, ESD	404.1800.1000.29.1.1	404.2000.1000.29.1.1
incl. cable tray with flap	404.1800.1000.29.2.0	404.2000.1000.29.2.0
incl. cable tray with flap, ESD	404.1800.1000.29.2.1	404.2000.1000.29.2.1

Table top for column height 1600 / 2200 mm

Table top thickness 27 mm ABS edge

- light gray table top (RAL 7035)
- Hard laminate (EN 438)
- with cutouts for QUADRO columns

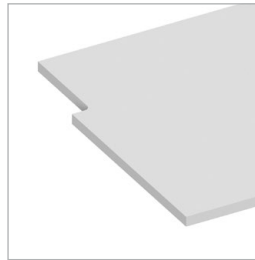

Table depth 800 mm

table width	1200 mm	1500 mm
Standard	404.1200.800.27.3.0	404.1500.800.27.3.0
Standard, ESD	404.1200.800.27.3.1	404.1500.800.27.3.1
incl. cable entry	404.1200.800.27.4.0	404.1500.800.27.4.0
incl. cable entry, ESD	404.1200.800.27.4.1	404.1500.800.27.4.1
incl. cable tray with flap	404.1200.800.27.5.0	404.1500.800.27.5.0
incl. cable tray with flap, ESD	404.1200.800.27.5.1	404.1500.800.27.5.1

table width	1800 mm	2000 mm
Standard	404.1800.800.27.3.0	404.2000.800.27.3.0
Standard, ESD	404.1800.800.27.3.1	404.2000.800.27.3.1
incl. cable entry	404.1800.800.27.4.0	404.2000.800.27.4.0
incl. cable entry, ESD	404.1800.800.27.4.1	404.2000.800.27.4.1
incl. cable tray with flap	404.1800.800.27.5.0	404.2000.800.27.5.0
incl. cable tray with flap, ESD	404.1800.800.27.5.1	404.2000.800.27.5.1

Table depth 1000 mm

table width	1200 mm	1500 mm
Standard	404.1200.1000.27.3.0	404.1500.1000.27.3.0
Standard, ESD	404.1200.1000.27.3.1	404.1500.1000.27.3.1
incl. cable entry	404.1200.1000.27.4.0	404.1500.1000.27.4.0
incl. cable entry, ESD	404.1200.1000.27.4.1	404.1500.1000.27.4.1
incl. cable tray with flap	404.1200.1000.27.5.0	404.1500.1000.27.5.0
incl. cable tray with flap, ESD	404.1200.1000.27.5.1	404.1500.1000.27.5.1

table width	1800 mm	2000 mm
Standard	404.1800.1000.27.3.0	404.2000.1000.27.3.0
Standard, ESD	404.1800.1000.27.3.1	404.2000.1000.27.3.1
incl. cable entry	404.1800.1000.27.4.0	404.2000.1000.27.4.0
incl. cable entry, ESD	404.1800.1000.27.4.1	404.2000.1000.27.4.1
incl. cable tray with flap	404.1800.1000.27.5.0	404.2000.1000.27.5.0
incl. cable tray with flap, ESD	404.1800.1000.27.5.1	404.2000.1000.27.5.1

Table top for column height 1600 / 2200 mm

Table top thickness 40 mm postformed edge

- light gray table top (RAL 7035)
- Hard laminate (EN 438)
- with cutouts for QUADRO columns

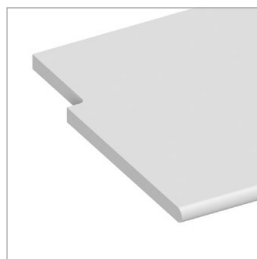

Table depth 800 mm

table width	1200 mm	1500 mm
Standard	404.1200.800.40.3.0	404.1500.800.40.3.0
Standard, ESD	404.1200.800.40.3.1	404.1500.800.40.3.1
incl. cable entry	404.1200.800.40.4.0	404.1500.800.40.4.0
incl. cable entry, ESD	404.1200.800.40.4.1	404.1500.800.40.4.1
incl. cable tray with flap	404.1200.800.40.5.0	404.1500.800.40.5.0
incl. cable tray with flap, ESD	404.1200.800.40.5.1	404.1500.800.40.5.1

table width	1800 mm	2000 mm
Standard	404.1800.800.40.3.0	404.2000.800.40.3.0
Standard, ESD	404.1800.800.40.3.1	404.2000.800.40.3.1
incl. cable entry	404.1800.800.40.4.0	404.2000.800.40.4.0
incl. cable entry, ESD	404.1800.800.40.4.1	404.2000.800.40.4.1
incl. cable tray with flap	404.1800.800.40.5.0	404.2000.800.40.5.0
incl. cable tray with flap, ESD	404.1800.800.40.5.1	404.2000.800.40.5.1

Table depth 1000 mm

table width	1200 mm	1500 mm
Standard	404.1200.1000.40.3.0	404.1500.1000.40.3.0
Standard, ESD	404.1200.1000.40.3.1	404.1500.1000.40.3.1
incl. cable entry	404.1200.1000.40.4.0	404.1500.1000.40.4.0
incl. cable entry, ESD	404.1200.1000.40.4.1	404.1500.1000.40.4.1
incl. cable tray with flap	404.1200.1000.40.5.0	404.1500.1000.40.5.0
incl. cable tray with flap, ESD	404.1200.1000.40.5.1	404.1500.1000.40.5.1

table width	1800 mm	2000 mm
Standard	404.1800.1000.40.3.0	404.2000.1000.40.3.0
Standard, ESD	404.1800.1000.40.3.1	404.2000.1000.40.3.1
incl. cable entry	404.1800.1000.40.4.0	404.2000.1000.40.4.0
incl. cable entry, ESD	404.1800.1000.40.4.1	404.2000.1000.40.4.1
incl. cable tray with flap	404.1800.1000.40.5.0	404.2000.1000.40.5.0
incl. cable tray with flap, ESD	404.1800.1000.40.5.1	404.2000.1000.40.5.1

Table top for column height 1600 / 2200 mm

Table top thickness 68/29 mm Postforming edge Premium

- light gray table top (RAL 7035)
- Hard laminate (EN 438)
- with cutouts for QUADRO columns

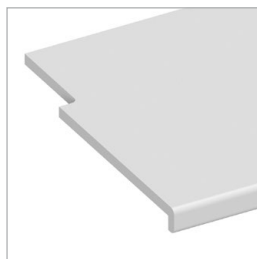

Table depth 800 mm

table width	1200 mm	1500 mm
Standard	404.1200.800.29.3.0	404.1500.800.29.3.0
Standard, ESD	404.1200.800.29.3.1	404.1500.800.29.3.1
incl. cable entry	404.1200.800.29.4.0	404.1500.800.29.4.0
incl. cable entry, ESD	404.1200.800.29.4.1	404.1500.800.29.4.1
incl. cable tray with flap	404.1200.800.29.5.0	404.1500.800.29.5.0
incl. cable tray with flap, ESD	404.1200.800.29.5.1	404.1500.800.29.5.1

table width	1800 mm	2000 mm
Standard	404.1800.800.29.3.0	404.2000.800.29.3.0
Standard, ESD	404.1800.800.29.3.1	404.2000.800.29.3.1
incl. cable entry	404.1800.800.29.4.0	404.2000.800.29.4.0
incl. cable entry, ESD	404.1800.800.29.4.1	404.2000.800.29.4.1
incl. cable tray with flap	404.1800.800.29.5.0	404.2000.800.29.5.0
incl. cable tray with flap, ESD	404.1800.800.29.5.1	404.2000.800.29.5.1

Table depth 1000 mm

table width	1200 mm	1500 mm
Standard	404.1200.1000.29.3.0	404.1500.1000.29.3.0
Standard, ESD	404.1200.1000.29.3.1	404.1500.1000.29.3.1
incl. cable entry	404.1200.1000.29.4.0	404.1500.1000.29.4.0
incl. cable entry, ESD	404.1200.1000.29.4.1	404.1500.1000.29.4.1
incl. cable tray with flap	404.1200.1000.29.5.0	404.1500.1000.29.5.0
incl. cable tray with flap, ESD	404.1200.1000.29.5.1	404.1500.1000.29.5.1

table width	1800 mm	2000 mm
Standard	404.1800.1000.29.3.0	404.2000.1000.29.3.0
Standard, ESD	404.1800.1000.29.3.1	404.2000.1000.29.3.1
incl. cable entry	404.1800.1000.29.4.0	404.2000.1000.29.4.0
incl. cable entry, ESD	404.1800.1000.29.4.1	404.2000.1000.29.4.1
incl. cable tray with flap	404.1800.1000.29.5.0	404.2000.1000.29.5.0
incl. cable tray with flap, ESD	404.1800.1000.29.5.1	404.2000.1000.29.5.1

Corner tabletops

Trapezoid

- light gray table top (RAL 7035)
- Hard laminate (EN 438)
- including mounting kit for mounting on the QUADRO columns

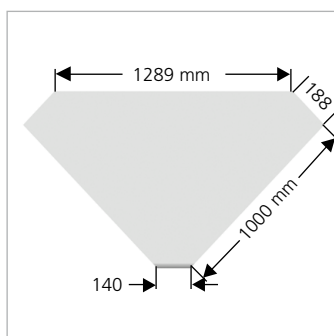
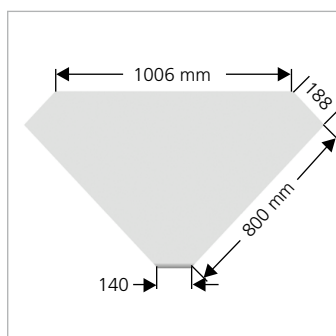

Table top thickness 27 mm ABS edge

table depth	800 mm	1000 mm
Standard	405.800.800.27.0.0	405.1000.1000.27.0.0
Standard, ESD	405.800.800.27.0.1	405.1000.1000.27.0.1
incl. cable entry	405.800.800.27.1.0	405.1000.1000.27.1.0
incl. cable entry, ESD	405.800.800.27.1.1	405.1000.1000.27.1.1

Table top thickness 40 mm postformed edge

table depth	800 mm	1000 mm
Standard	405.800.800.40.0.0	405.1000.1000.40.0.0
Standard, ESD	405.800.800.40.0.1	405.1000.1000.40.0.1
incl. cable entry	405.800.800.40.1.0	405.1000.1000.40.1.0
incl. cable entry, ESD	405.800.800.40.1.1	405.1000.1000.40.1.1

Table top thickness 68/29 mm Postforming edge Premium

table depth	800 mm	1000 mm
Standard	405.800.800.29.0.0	405.1000.1000.29.0.0
Standard, ESD	405.800.800.29.0.1	405.1000.1000.29.0.1
incl. cable entry	405.800.800.29.1.0	405.1000.1000.29.1.0
incl. cable entry, ESD	405.800.800.29.1.1	405.1000.1000.29.1.1

QUADRO twin 400

Square

- light gray table top (RAL 7035)
- Hard laminate (EN 438)
- including mounting kit for mounting on the QUADRO columns
- including height-adjustable table leg

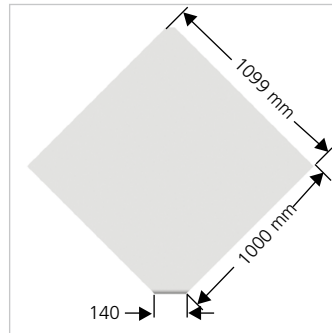
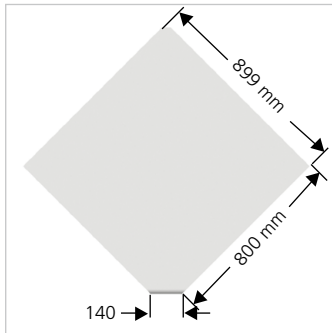

Table top thickness 27 mm ABS edge

table depth	800 mm	1000 mm
Standard	406.800.800.27.0.0	406.1000.1000.27.0.0
Standard, ESD	406.800.800.27.0.1	406.1000.1000.27.0.1
incl. cable entry	406.800.800.27.1.0	406.1000.1000.27.1.0
incl. cable entry, ESD	406.800.800.27.1.1	406.1000.1000.27.1.1

Table top thickness 40 mm postformed edge

table depth	800 mm	1000 mm
Standard	406.800.800.40.0.0	406.1000.1000.40.0.0
Standard, ESD	406.800.800.40.0.1	406.1000.1000.40.0.1
incl. cable entry	406.800.800.40.1.0	406.1000.1000.40.1.0
incl. cable entry, ESD	406.800.800.40.1.1	406.1000.1000.40.1.1

Table top thickness 68/29 mm Postforming edge Premium

table depth	800 mm	1000 mm
Standard	406.800.800.29.0.0	406.1000.1000.29.0.0
Standard, ESD	406.800.800.29.0.1	406.1000.1000.29.0.1
incl. cable entry	406.800.800.29.1.0	406.1000.1000.29.1.0
incl. cable entry, ESD	406.800.800.29.1.1	406.1000.1000.29.1.1

QUADRO twin 500

Manually height adjustable with clamp

- **Table height: height adjustment range 735 - 955 mm**
- 220 mm height adjustable
- load capacity: max. surface load 200 kg

Consisting of:

- frame
- set of pillars on the left
- set of pillars on the right
- table top

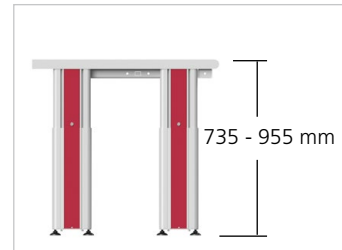

QUADRO twin 500

Framework

- steel frame for mounting the table top
- conductive powder-coated, light gray (RAL 7035)
- 4 different table widths
- 2 different table depths



Optional: in ESD design according to IEC 61340-5-1



- grounding box with two 10 mm push-button connections
- central earthing point for connecting the ESD or protective earth



Table depth: 800 mm

table width	1200 mm	1500 mm	1800 mm	2000 mm
Standard	501.1200.800.0	501.1500.800.0	501.1800.800.0	501.2000.800.0
ESD	501.1200.800.1	501.1500.800.1	501.1800.800.1	501.2000.800.1

Table depth: 1000 mm

table width	1200 mm	1500 mm	1800 mm	2000 mm
Standard	501.1200.1000.0	501.1500.1000.0	501.1800.1000.0	501.2000.1000.0
ESD	501.1200.1000.1	501.1500.1000.1	501.1800.1000.1	501.2000.1000.1

Columns

- QUADRO column made of aluminum as a functional and optical basic element
- manually height adjustable, 735 - 955 mm
- conductive powder-coated, light gray (RAL 7035)
- color accents with decorative elements in the pillars
- conductive height adjustment elements in the foot parts
- legroom with corner table combinations thanks to table legs that can be moved to the rear

Consisting of:

- basic pillar
- foot part
- optional add-on column

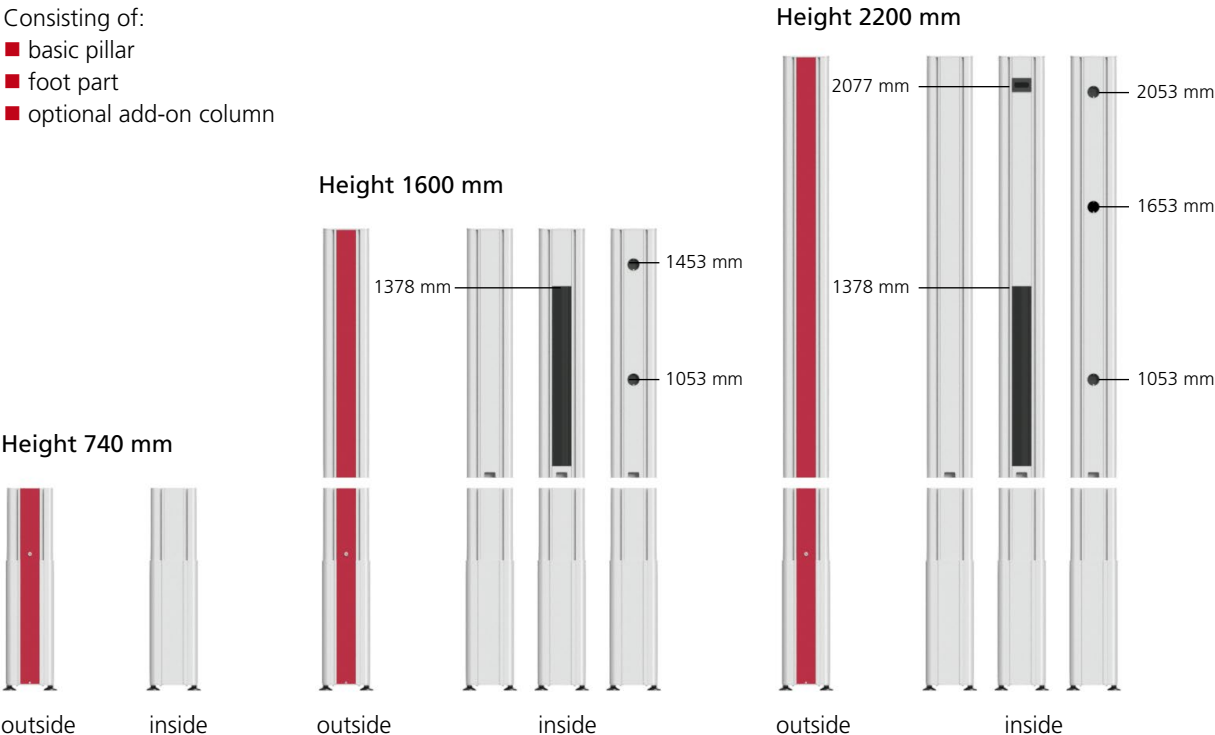

with decorative element	with brush element	with Schuko sockets	with Swiss sockets
-------------------------	--------------------	---------------------	--------------------

Energy, compressed air and data lines can be installed in the two cable ducts of the QUADRO columns be relocated.

Integrated brush strips e.g. for cable routing in connection with cable tray and / or 19" structure.

Integrated Schuko sockets on the inside e.g. for electrifying the upper shelves.

Integrated Swiss plug cans on the inside e.g. to electrify the upper shelves.

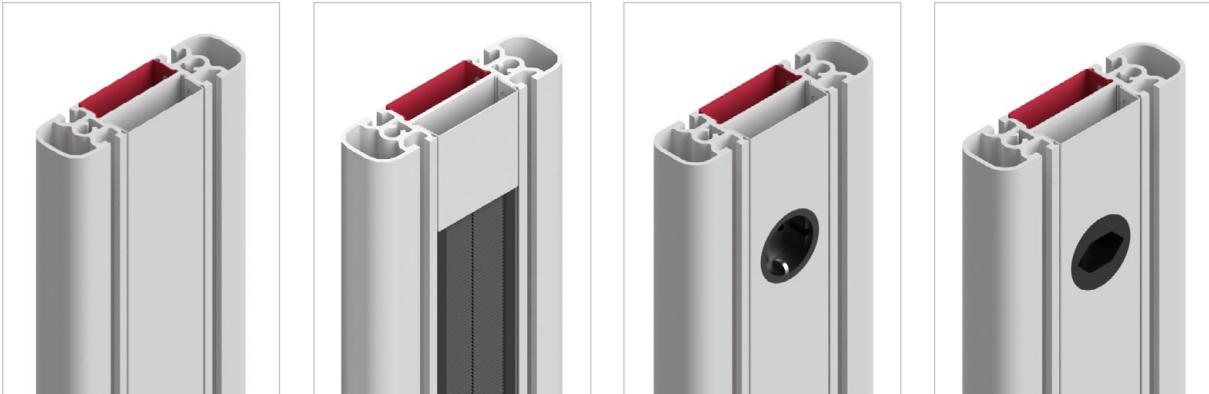

QUADRO twin 500

Set of pillars on the left

- QUADRO column made of aluminum as a functional and optical basic element
- manually height adjustable, 735 - 955 mm
- conductive powder-coated, light gray (RAL 7035)
- 3 different column heights

Optional:

- decorative element on the outside
- brush above the table top, on the inside
- sockets above the table top, on the inside
- prepared for table top including cable tray with flap for column height 780 mm / 1600 mm / 2200 mm









Set of pillars on the left

column height	740 / 740 mm	740 / 1600 mm	740 / 2200 mm
without decorative element	---	---	---
decorative element plug-in profile	---	---	---
decorative element snap-in profile	502.740.740.1._ _	502.740.1600.1._ _	502.740.2200.1._ _
brush	---	502.740.1600.2._ _	502.740.2200.2._ _
socket D	---	502.740.1600.3._ _	502.740.2200.3._ _
socket CH	---	502.740.1600.4._ _	502.740.2200.4._ _

Set of pillars on the left - for table top including cable tray with flap

Tabletop thickness	27 mm	29 mm	40 mm
column height	740 / 740 mm	740 / 740 mm	740 / 740 mm
without decorative element	---	---	---
decorative element plug-in profile	---	---	---
decorative element snap-in profile	502.740.740.27.1._ _	502.740.740.29.1._ _	502.740.740.40.1._ _

Please add the color key for the decorative elements to the article number:

	lichtgrau (RAL 7035)	.._._._.70
	water blue (RAL 5021)	.._._._.02
	cobalt blue (RAL 5013)	.._._._.03
	raspberry red (RAL 3027)	.._._._.04
	zinc yellow (RAL 1018)	.._._._.06
	pigeon blue (RAL 5014)	.._._._.08

Other colors for realizing your corporate identity on request

Set of pillars on the right

- QUADRO column made of aluminum as a functional and optical basic element
- manually height adjustable, 735 - 955 mm
- conductive powder-coated, light gray (RAL 7035)
- 3 different column heights

Optional:

- decorative element on the outside
- brush above the table top, on the inside
- sockets above the table top, on the inside
- prepared for table top including cable tray with flap for column height 780 mm / 1600 mm / 2200 mm









Set of pillars on the right

column height	740 / 740 mm	740 / 1600 mm	740 / 2200 mm
without decorative element	---	---	---
decorative element plug-in profile	---	---	---
decorative element snap-in profile	503.740.740.1._ _	503.740.1600.1._ _	503.740.2200.1._ _
brush	---	503.740.1600.2._ _	503.740.2200.2._ _
socket D	---	503.740.1600.3._ _	503.740.2200.3._ _
socket CH	---	503.740.1600.4._ _	503.740.2200.4._ _

Set of pillars on the right - for table top including cable tray with flap

Tabletop thickness	27 mm	29 mm	40 mm
column height	740 / 740 mm	740 / 740 mm	740 / 740 mm
without decorative element	---	---	---
decorative element plug-in profile	---	---	---
decorative element snap-in profile	503.740.740.27.1._ _	503.740.740.29.1._ _	503.740.740.40.1._ _

Please add the color key for the decorative elements to the article number:

	lichtgrau (RAL 7035)	__._._._.70
	water blue (RAL 5021)	__._._._.02
	cobalt blue (RAL 5013)	__._._._.03
	raspberry red (RAL 3027)	__._._._.04
	zinc yellow (RAL 1018)	__._._._.06
	pigeon blue (RAL 5014)	__._._._.08

Other colors for realizing your corporate identity on request

QUADRO twin 500

Table tops

- light gray table top (RAL 7035)
- protected with robust edge band
- slightly structured surface, glare-free and highly scratch-resistant
- briefly heat-resistant up to 180°C
- resistant to organic solvents, weak acids and alkalis, gasoline and oil

Standard:

- Hard laminate (EN 438)
- very hard and abrasion-resistant HPL laminate

ESD version:

- conductive ESD Hard laminate (EN 438)
- very hard and abrasion-resistant, conductive HPL laminate
- volume conductive carrier plate
- leakage resistance < 10⁹ Ohm (dry measurement according to nach IEC 61340-5-1, 100 V)

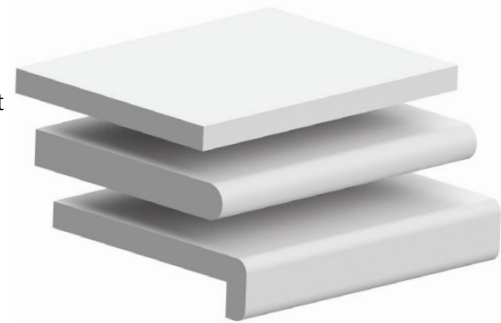

Table top edges / thicknesses

- ABS edge (Acrylnitril-Butadien-Styrol) 27 mm
- Postforming edge 40 mm
- Postforming edge Premium 68/29 mm

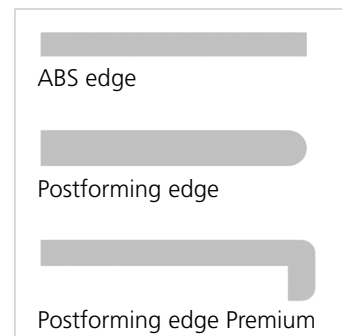

Table top including cable duct

- Ø 80 mm
- 2 recesses in the width of the table 1200 mm and 1500 mm
- 3 recesses in the width of the table 1800 mm and 2000 mm
- 3 recesses in the corner table top
- including cable entry sets



Table top including cable tray with flap

- cable tray integrated in the table top with hinged cover
- cable tray D = 200 mm
- cover divided in the middle for table width 1800 mm und 2000 mm
- with brush strip for cable entry when the cover is closed

Optional:

- Electrical insert strip, prepared for individual assembly with insert plates (page 107)
 - table width 1200 mm: 900 mm usable width for insert panels
 - table width 1500 mm: 1200 mm usable width for insert panels
 - table width 1800 mm: 1500 mm usable width for insert panels
 - table width 2000 mm: 1700 mm usable width for insert panels



Table top for column height 740 mm

Table top thickness 27 mm ABS edge

- light gray table top (RAL 7035)
- Hard laminate (EN 438)

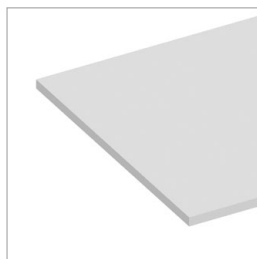

Table depth 800 mm

table width	1200 mm	1500 mm
Standard	504.1200.800.27.0.0	504.1500.800.27.0.0
Standard, ESD	504.1200.800.27.0.1	504.1500.800.27.0.1
incl. cable entry	504.1200.800.27.1.0	504.1500.800.27.1.0
incl. cable entry, ESD	504.1200.800.27.1.1	504.1500.800.27.1.1
incl. cable tray with flap	504.1200.800.27.2.0	504.1500.800.27.2.0
incl. cable tray with flap, ESD	504.1200.800.27.2.1	504.1500.800.27.2.1

table width	1800 mm	2000 mm
Standard	504.1800.800.27.0.0	504.2000.800.27.0.0
Standard, ESD	504.1800.800.27.0.1	504.2000.800.27.0.1
incl. cable entry	504.1800.800.27.1.0	504.2000.800.27.1.0
incl. cable entry, ESD	504.1800.800.27.1.1	504.2000.800.27.1.1
incl. cable tray with flap	504.1800.800.27.2.0	504.2000.800.27.2.0
incl. cable tray with flap, ESD	504.1800.800.27.2.1	504.2000.800.27.2.1

Table depth 1000 mm

table width	1200 mm	1500 mm
Standard	504.1200.1000.27.0.0	504.1500.1000.27.0.0
Standard, ESD	504.1200.1000.27.0.1	504.1500.1000.27.0.1
incl. cable entry	504.1200.1000.27.1.0	504.1500.1000.27.1.0
incl. cable entry, ESD	504.1200.1000.27.1.1	504.1500.1000.27.1.1
incl. cable tray with flap	504.1200.1000.27.2.0	504.1500.1000.27.2.0
incl. cable tray with flap, ESD	504.1200.1000.27.2.1	504.1500.1000.27.2.1

table width	1800 mm	2000 mm
Standard	504.1800.1000.27.0.0	504.2000.1000.27.0.0
Standard, ESD	504.1800.1000.27.0.1	504.2000.1000.27.0.1
incl. cable entry	504.1800.1000.27.1.0	504.2000.1000.27.1.0
incl. cable entry, ESD	504.1800.1000.27.1.1	504.2000.1000.27.1.1
incl. cable tray with flap	504.1800.1000.27.2.0	504.2000.1000.27.2.0
incl. cable tray with flap, ESD	504.1800.1000.27.2.1	504.2000.1000.27.2.1

Table top for column height 740 mm

Table top thickness 40 mm postformed edge

- light gray table top (RAL 7035)
- Hard laminate (EN 438)

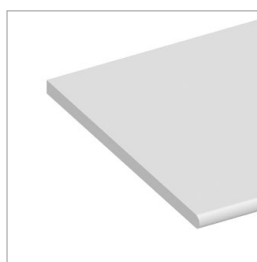

Table depth 800 mm

table width	1200 mm	1500 mm
Standard	504.1200.800.40.0.0	504.1500.800.40.0.0
Standard, ESD	504.1200.800.40.0.1	504.1500.800.40.0.1
incl. cable entry	504.1200.800.40.1.0	504.1500.800.40.1.0
incl. cable entry, ESD	504.1200.800.40.1.1	504.1500.800.40.1.1
incl. cable tray with flap	504.1200.800.40.2.0	504.1500.800.40.2.0
incl. cable tray with flap, ESD	504.1200.800.40.2.1	504.1500.800.40.2.1

table width	1800 mm	2000 mm
Standard	504.1800.800.40.0.0	504.2000.800.40.0.0
Standard, ESD	504.1800.800.40.0.1	504.2000.800.40.0.1
incl. cable entry	504.1800.800.40.1.0	504.2000.800.40.1.0
incl. cable entry, ESD	504.1800.800.40.1.1	504.2000.800.40.1.1
incl. cable tray with flap	504.1800.800.40.2.0	504.2000.800.40.2.0
incl. cable tray with flap, ESD	504.1800.800.40.2.1	504.2000.800.40.2.1

Table depth 1000 mm

table width	1200 mm	1500 mm
Standard	504.1200.1000.40.0.0	504.1500.1000.40.0.0
Standard, ESD	504.1200.1000.40.0.1	504.1500.1000.40.0.1
incl. cable entry	504.1200.1000.40.1.0	504.1500.1000.40.1.0
incl. cable entry, ESD	504.1200.1000.40.1.1	504.1500.1000.40.1.1
incl. cable tray with flap	504.1200.1000.40.2.0	504.1500.1000.40.2.0
incl. cable tray with flap, ESD	504.1200.1000.40.2.1	504.1500.1000.40.2.1

table width	1800 mm	2000 mm
Standard	504.1800.1000.40.0.0	504.2000.1000.40.0.0
Standard, ESD	504.1800.1000.40.0.1	504.2000.1000.40.0.1
incl. cable entry	504.1800.1000.40.1.0	504.2000.1000.40.1.0
incl. cable entry, ESD	504.1800.1000.40.1.1	504.2000.1000.40.1.1
incl. cable tray with flap	504.1800.1000.40.2.0	504.2000.1000.40.2.0
incl. cable tray with flap, ESD	504.1800.1000.40.2.1	504.2000.1000.40.2.1

Table top for column height 740 mm

Table top thickness 68/29 mm Postforming edge Premium

- light gray table top (RAL 7035)
- Hard laminate (EN 438)

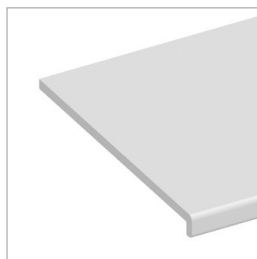

Table depth 800 mm

table width	1200 mm	1500 mm
Standard	504.1200.800.29.0.0	504.1500.800.29.0.0
Standard, ESD	504.1200.800.29.0.1	504.1500.800.29.0.1
incl. cable entry	504.1200.800.29.1.0	504.1500.800.29.1.0
incl. cable entry, ESD	504.1200.800.29.1.1	504.1500.800.29.1.1
incl. cable tray with flap	504.1200.800.29.2.0	504.1500.800.29.2.0
incl. cable tray with flap, ESD	504.1200.800.29.2.1	504.1500.800.29.2.1

table width	1800 mm	2000 mm
Standard	504.1800.800.29.0.0	504.2000.800.29.0.0
Standard, ESD	504.1800.800.29.0.1	504.2000.800.29.0.1
incl. cable entry	504.1800.800.29.1.0	504.2000.800.29.1.0
incl. cable entry, ESD	504.1800.800.29.1.1	504.2000.800.29.1.1
incl. cable tray with flap	504.1800.800.29.2.0	504.2000.800.29.2.0
incl. cable tray with flap, ESD	504.1800.800.29.2.1	504.2000.800.29.2.1

Table depth 1000 mm

table width	1200 mm	1500 mm
Standard	504.1200.1000.29.0.0	504.1500.1000.29.0.0
Standard, ESD	504.1200.1000.29.0.1	504.1500.1000.29.0.1
incl. cable entry	504.1200.1000.29.1.0	504.1500.1000.29.1.0
incl. cable entry, ESD	504.1200.1000.29.1.1	504.1500.1000.29.1.1
incl. cable tray with flap	504.1200.1000.29.2.0	504.1500.1000.29.2.0
incl. cable tray with flap, ESD	504.1200.1000.29.2.1	504.1500.1000.29.2.1

table width	1800 mm	2000 mm
Standard	504.1800.1000.29.0.0	504.2000.1000.29.0.0
Standard, ESD	504.1800.1000.29.0.1	504.2000.1000.29.0.1
incl. cable entry	504.1800.1000.29.1.0	504.2000.1000.29.1.0
incl. cable entry, ESD	504.1800.1000.29.1.1	504.2000.1000.29.1.1
incl. cable tray with flap	504.1800.1000.29.2.0	504.2000.1000.29.2.0
incl. cable tray with flap, ESD	504.1800.1000.29.2.1	504.2000.1000.29.2.1

Table top for column height 1600 / 2200 mm

Table top thickness 27 mm ABS edge

- light gray table top (RAL 7035)
- Hard laminate (EN 438)
- with cutouts for QUADRO columns

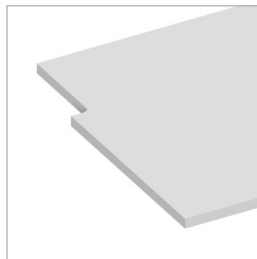

Table depth 800 mm

table width	1200 mm	1500 mm
Standard	504.1200.800.27.3.0	504.1500.800.27.3.0
Standard, ESD	504.1200.800.27.3.1	504.1500.800.27.3.1
incl. cable entry	504.1200.800.27.4.0	504.1500.800.27.4.0
incl. cable entry, ESD	504.1200.800.27.4.1	504.1500.800.27.4.1
incl. cable tray with flap	504.1200.800.27.5.0	504.1500.800.27.5.0
incl. cable tray with flap, ESD	504.1200.800.27.5.1	504.1500.800.27.5.1

table width	1800 mm	2000 mm
Standard	504.1800.800.27.3.0	504.2000.800.27.3.0
Standard, ESD	504.1800.800.27.3.1	504.2000.800.27.3.1
incl. cable entry	504.1800.800.27.4.0	504.2000.800.27.4.0
incl. cable entry, ESD	504.1800.800.27.4.1	504.2000.800.27.4.1
incl. cable tray with flap	504.1800.800.27.5.0	504.2000.800.27.5.0
incl. cable tray with flap, ESD	504.1800.800.27.5.1	504.2000.800.27.5.1

Table depth 1000 mm

table width	1200 mm	1500 mm
Standard	504.1200.1000.27.3.0	504.1500.1000.27.3.0
Standard, ESD	504.1200.1000.27.3.1	504.1500.1000.27.3.1
incl. cable entry	504.1200.1000.27.4.0	504.1500.1000.27.4.0
incl. cable entry, ESD	504.1200.1000.27.4.1	504.1500.1000.27.4.1
incl. cable tray with flap	504.1200.1000.27.5.0	504.1500.1000.27.5.0
incl. cable tray with flap, ESD	504.1200.1000.27.5.1	504.1500.1000.27.5.1

table width	1800 mm	2000 mm
Standard	504.1800.1000.27.3.0	504.2000.1000.27.3.0
Standard, ESD	504.1800.1000.27.3.1	504.2000.1000.27.3.1
incl. cable entry	504.1800.1000.27.4.0	504.2000.1000.27.4.0
incl. cable entry, ESD	504.1800.1000.27.4.1	504.2000.1000.27.4.1
incl. cable tray with flap	504.1800.1000.27.5.0	504.2000.1000.27.5.0
incl. cable tray with flap, ESD	504.1800.1000.27.5.1	504.2000.1000.27.5.1

Table top for column height 1600 / 2200 mm

Table top thickness 40 mm postformed edge

- light gray table top (RAL 7035)
- Hard laminate (EN 438)
- with cutouts for QUADRO columns

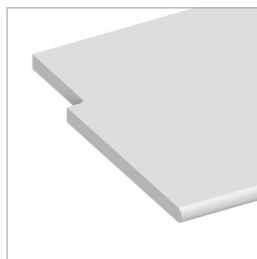

Table depth 800 mm

table width	1200 mm	1500 mm
Standard	504.1200.800.40.3.0	504.1500.800.40.3.0
Standard, ESD	504.1200.800.40.3.1	504.1500.800.40.3.1
incl. cable entry	504.1200.800.40.4.0	504.1500.800.40.4.0
incl. cable entry, ESD	504.1200.800.40.4.1	504.1500.800.40.4.1
incl. cable tray with flap	504.1200.800.40.5.0	504.1500.800.40.5.0
incl. cable tray with flap, ESD	504.1200.800.40.5.1	504.1500.800.40.5.1

table width	1800 mm	2000 mm
Standard	504.1800.800.40.3.0	504.2000.800.40.3.0
Standard, ESD	504.1800.800.40.3.1	504.2000.800.40.3.1
incl. cable entry	504.1800.800.40.4.0	504.2000.800.40.4.0
incl. cable entry, ESD	504.1800.800.40.4.1	504.2000.800.40.4.1
incl. cable tray with flap	504.1800.800.40.5.0	504.2000.800.40.5.0
incl. cable tray with flap, ESD	504.1800.800.40.5.1	504.2000.800.40.5.1

Table depth 1000 mm

table width	1200 mm	1500 mm
Standard	504.1200.1000.40.3.0	504.1500.1000.40.3.0
Standard, ESD	504.1200.1000.40.3.1	504.1500.1000.40.3.1
incl. cable entry	504.1200.1000.40.4.0	504.1500.1000.40.4.0
incl. cable entry, ESD	504.1200.1000.40.4.1	504.1500.1000.40.4.1
incl. cable tray with flap	504.1200.1000.40.5.0	504.1500.1000.40.5.0
incl. cable tray with flap, ESD	504.1200.1000.40.5.1	504.1500.1000.40.5.1

table width	1800 mm	2000 mm
Standard	504.1800.1000.40.3.0	504.2000.1000.40.3.0
Standard, ESD	504.1800.1000.40.3.1	504.2000.1000.40.3.1
incl. cable entry	504.1800.1000.40.4.0	504.2000.1000.40.4.0
incl. cable entry, ESD	504.1800.1000.40.4.1	504.2000.1000.40.4.1
incl. cable tray with flap	504.1800.1000.40.5.0	504.2000.1000.40.5.0
incl. cable tray with flap, ESD	504.1800.1000.40.5.1	504.2000.1000.40.5.1

Table top for column height 1600 / 2200 mm

Table top thickness 68/29 mm Postforming edge Premium

- light gray table top (RAL 7035)
- Hard laminate (EN 438)
- with cutouts for QUADRO columns

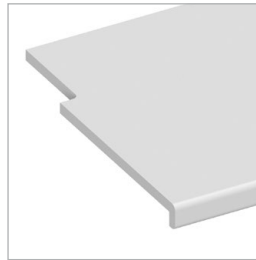

Table depth 800 mm

table width	1200 mm	1500 mm
Standard	504.1200.800.29.3.0	504.1500.800.29.3.0
Standard, ESD	504.1200.800.29.3.1	504.1500.800.29.3.1
incl. cable entry	504.1200.800.29.4.0	504.1500.800.29.4.0
incl. cable entry, ESD	504.1200.800.29.4.1	504.1500.800.29.4.1
incl. cable tray with flap	504.1200.800.29.5.0	504.1500.800.29.5.0
incl. cable tray with flap, ESD	504.1200.800.29.5.1	504.1500.800.29.5.1

table width	1800 mm	2000 mm
Standard	504.1800.800.29.3.0	504.2000.800.29.3.0
Standard, ESD	504.1800.800.29.3.1	504.2000.800.29.3.1
incl. cable entry	504.1800.800.29.4.0	504.2000.800.29.4.0
incl. cable entry, ESD	504.1800.800.29.4.1	504.2000.800.29.4.1
incl. cable tray with flap	504.1800.800.29.5.0	504.2000.800.29.5.0
incl. cable tray with flap, ESD	504.1800.800.29.5.1	504.2000.800.29.5.1

Table depth 1000 mm

table width	1200 mm	1500 mm
Standard	504.1200.1000.29.3.0	504.1500.1000.29.3.0
Standard, ESD	504.1200.1000.29.3.1	504.1500.1000.29.3.1
incl. cable entry	504.1200.1000.29.4.0	504.1500.1000.29.4.0
incl. cable entry, ESD	504.1200.1000.29.4.1	504.1500.1000.29.4.1
incl. cable tray with flap	504.1200.1000.29.5.0	504.1500.1000.29.5.0
incl. cable tray with flap, ESD	504.1200.1000.29.5.1	504.1500.1000.29.5.1

table width	1800 mm	2000 mm
Standard	504.1800.1000.29.3.0	504.2000.1000.29.3.0
Standard, ESD	504.1800.1000.29.3.1	504.2000.1000.29.3.1
incl. cable entry	504.1800.1000.29.4.0	504.2000.1000.29.4.0
incl. cable entry, ESD	504.1800.1000.29.4.1	504.2000.1000.29.4.1
incl. cable tray with flap	504.1800.1000.29.5.0	504.2000.1000.29.5.0
incl. cable tray with flap, ESD	504.1800.1000.29.5.1	504.2000.1000.29.5.1

Corner tabletops

Trapezoid

- light gray table top (RAL 7035)
- Hard laminate (EN 438)
- including mounting kit for mounting on the QUADRO columns

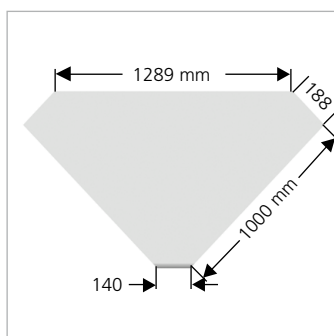
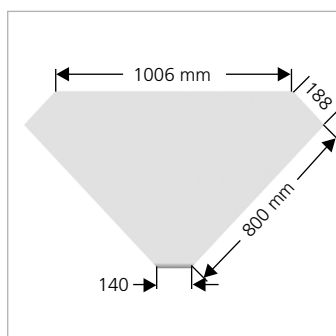

Table top thickness 27 mm ABS edge

table depth	800 mm	1000 mm
Standard	505.800.800.27.0.0	505.1000.1000.27.0.0
Standard, ESD	505.800.800.27.0.1	505.1000.1000.27.0.1
incl. cable entry	505.800.800.27.1.0	505.1000.1000.27.1.0
incl. cable entry, ESD	505.800.800.27.1.1	505.1000.1000.27.1.1

Table top thickness 40 mm postformed edge

table depth	800 mm	1000 mm
Standard	505.800.800.40.0.0	505.1000.1000.40.0.0
Standard, ESD	505.800.800.40.0.1	505.1000.1000.40.0.1
incl. cable entry	505.800.800.40.1.0	505.1000.1000.40.1.0
incl. cable entry, ESD	505.800.800.40.1.1	505.1000.1000.40.1.1

Table top thickness 68/29 mm Postforming edge Premium

table depth	800 mm	1000 mm
Standard	505.800.800.29.0.0	505.1000.1000.29.0.0
Standard, ESD	505.800.800.29.0.1	505.1000.1000.29.0.1
incl. cable entry	505.800.800.29.1.0	505.1000.1000.29.1.0
incl. cable entry, ESD	505.800.800.29.1.1	505.1000.1000.29.1.1

QUADRO twin 500

Square

- light gray table top (RAL 7035)
- Hard laminate (EN 438)
- including mounting kit for mounting on the QUADRO columns
- including height-adjustable table leg

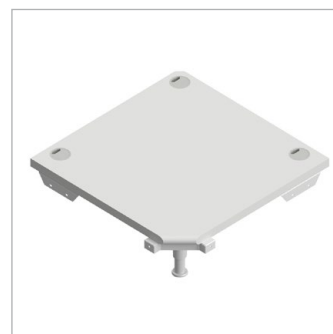
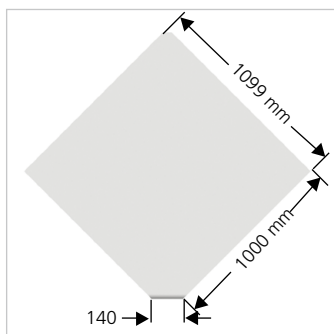
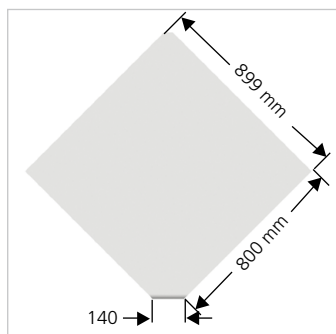

Table top thickness 27 mm ABS edge

table depth	800 mm	1000 mm
Standard	506.800.800.27.0.0	506.1000.1000.27.0.0
Standard, ESD	506.800.800.27.0.1	506.1000.1000.27.0.1
incl. cable entry	506.800.800.27.1.0	506.1000.1000.27.1.0
incl. cable entry, ESD	506.800.800.27.1.1	506.1000.1000.27.1.1

Table top thickness 40 mm postformed edge

table depth	800 mm	1000 mm
Standard	506.800.800.40.0.0	506.1000.1000.40.0.0
Standard, ESD	506.800.800.40.0.1	506.1000.1000.40.0.1
incl. cable entry	506.800.800.40.1.0	506.1000.1000.40.1.0
incl. cable entry, ESD	506.800.800.40.1.1	506.1000.1000.40.1.1

Table top thickness 68/29 mm Postforming edge Premium

table depth	800 mm	1000 mm
Standard	506.800.800.29.0.0	506.1000.1000.29.0.0
Standard, ESD	506.800.800.29.0.1	506.1000.1000.29.0.1
incl. cable entry	506.800.800.29.1.0	506.1000.1000.29.1.0
incl. cable entry, ESD	506.800.800.29.1.1	506.1000.1000.29.1.1

QUADRO twin 600

Height adjustable with electrohydraulics drive

- **Table height: height adjustment range 730 - 1070 mm**
- height adjustable 340 mm
- load capacity: max. surface load 200 kg
- including cable tray with integrated privacy screen
- electric drive with intelligent control
- cable remote control with digital display and 4 position memories

Consisting of:

- frame
- set of pillars on the left
- set of pillars on the right
- table top

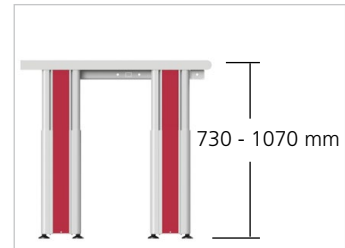

QUADRO twin 600

Framework

- steel frame for mounting the table top
- conductive powder-coated, light gray (RAL 7035)
- 4 different table widths
- 2 different table depths



Optional: in ESD design according to IEC 61340-5-1



- grounding box with two 10 mm push-button connections
- central earthing point for connecting the ESD or protective earth



Table depth: 800 mm

table width	1200 mm	1500 mm	1800 mm	2000 mm
Standard	601.1200.800.0	601.1500.800.0	601.1800.800.0	601.2000.800.0
ESD	601.1200.800.1	601.1500.800.1	601.1800.800.1	601.2000.800.1

Table depth: 1000 mm

table width	1200 mm	1500 mm	1800 mm	2000 mm
Standard	601.1200.1000.0	601.1500.1000.0	601.1800.1000.0	601.2000.1000.0
ESD	601.1200.1000.1	601.1500.1000.1	601.1800.1000.1	601.2000.1000.1

Columns

- QUADRO column made of aluminum as a functional and optical basic element
- height adjustable with electrohydraulics, 730 - 1070 mm
- conductive powder-coated, light gray (RAL 7035)
- color accents with decorative elements in the pillars
- conductive height adjustment elements in the foot parts
- legroom with corner table combinations thanks to table legs that can be moved to the rear

Consisting of:

- basic pillar
- foot part
- optional add-on column

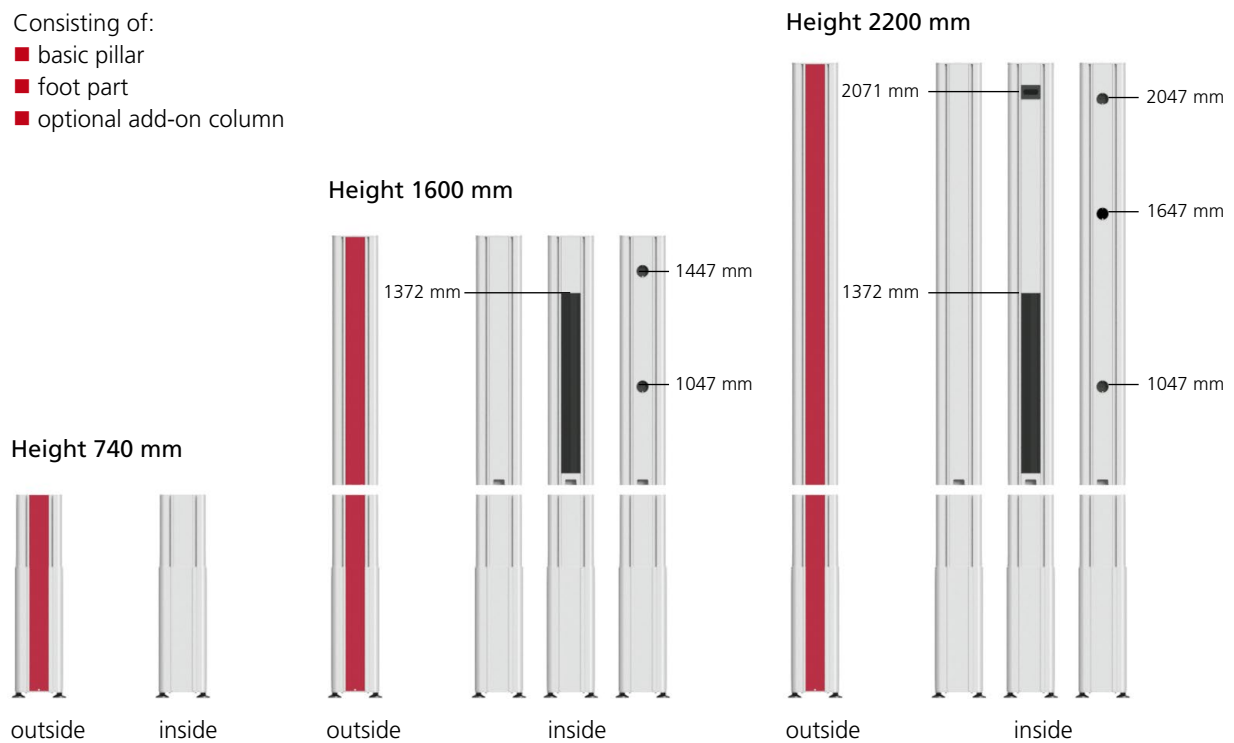

with decorative element	with brush element	with Schuko sockets	with Swiss sockets
-------------------------	--------------------	---------------------	--------------------

Energy, compressed air and data lines can be installed in the two cable ducts of the QUADRO columns be relocated.

Integrated brush strips e.g. for cable routing in connection with cable tray and / or 19" structure.

Integrated Schuko sockets on the inside e.g. for electrifying the upper shelves.

Integrated Swiss sockets on the inside e.g. to electrify the upper shelves.

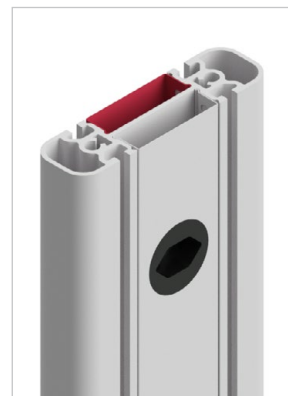
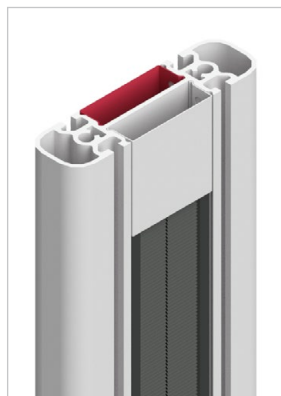
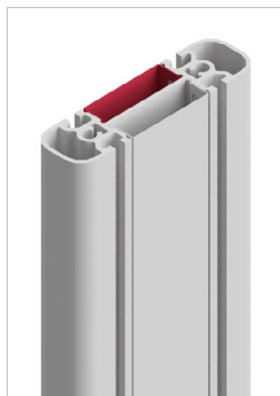

QUADRO twin 600

Set of pillars on the left

- QUADRO column made of aluminum as a functional and optical basic element
- height adjustable with electrohydraulics, 730 - 1070 mm
- conductive powder-coated, light gray (RAL 7035)
- 3 different column heights

Optional:







- decorative element on the outside
- brush above the table top, on the inside
- sockets above the table top, on the inside
for column height 780 mm / 1600 mm / 2200 mm



Set of pillars on the left

column height	740 / 740 mm	740 / 1600 mm	740 / 2200 mm
without decorative element	---	---	---
decorative element plug-in profile	---	---	---
decorative element snap-in profile	602.740.740.1._ _	602.740.1600.1._ _	602.740.2200.1._ _
brush	---	602.740.1600.2._ _	602.740.2200.2._ _
socket D	---	602.740.1600.3._ _	602.740.2200.3._ _
socket CH	---	602.740.1600.4._ _	602.740.2200.4._ _

Please add the color key for the decorative elements to the article number:

	lichtgrau (RAL 7035)	__ . __ . __ . __ . .70
	water blue (RAL 5021)	__ . __ . __ . __ . .02
	cobalt blue (RAL 5013)	__ . __ . __ . __ . .03
	raspberry red (RAL 3027)	__ . __ . __ . __ . .04
	zinc yellow (RAL 1018)	__ . __ . __ . __ . .06
	pigeon blue (RAL 5014)	__ . __ . __ . __ . .08

Other colors for realizing your corporate identity on request

Set of pillars on the right

- QUADRO column made of aluminum as a functional and optical basic element
- height adjustable with electrohydraulics, 730 - 1070 mm
- conductive powder-coated, light gray (RAL 7035)
- 3 different column heights

Optional:







- decorative element on the outside
- brush above the table top, on the inside
- sockets above the table top, on the inside
for column height 780 mm / 1600 mm / 2200 mm



Set of pillars on the right

column height	740 / 740 mm	740 / 1600 mm	740 / 2200 mm
without decorative element	---	---	---
decorative element plug-in profile	---	---	---
decorative element snap-in profile	603.740.740.1._ _	603.740.1600.1._ _	603.740.2200.1._ _
brush	---	603.740.1600.2._ _	603.740.2200.2._ _
socket D	---	603.740.1600.3._ _	603.740.2200.3._ _
socket CH	---	603.740.1600.4._ _	603.740.2200.4._ _

Please add the color key for the decorative elements to the article number:

	lichtgrau (RAL 7035)	_. _ . _ . _ .70
	water blue (RAL 5021)	_. _ . _ . _ .02
	cobalt blue (RAL 5013)	_. _ . _ . _ .03
	raspberry red (RAL 3027)	_. _ . _ . _ .04
	zinc yellow (RAL 1018)	_. _ . _ . _ .06
	pigeon blue (RAL 5014)	_. _ . _ . _ .08

Other colors for realizing your corporate identity on request

QUADRO twin 600

Table tops

- light gray table top (RAL 7035)
- protected with robust edge band
- slightly structured surface, glare-free and highly scratch-resistant
- briefly heat-resistant up to 180°C
- resistant to organic solvents, weak acids and alkalis, gasoline and oil

Standard:

- Hard laminate (EN 438)
- very hard and abrasion-resistant HPL laminate

ESD version:

- conductive ESD Hard laminate (EN 438)
- very hard and abrasion-resistant, conductive HPL laminate
- volume conductive carrier plate
- leakage resistance $< 10^9$ Ohm (dry measurement according to nach IEC 61340-5-1, 100 V)



Table top edges / thicknesses

- ABS edge (Acrylnitril-Butadien-Styrol) 27 mm
- Postforming edge 40 mm
- Postforming edge Premium 68/29 mm

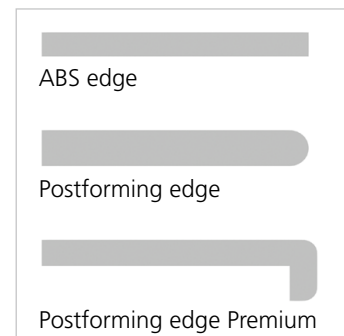

Table top including cable duct

- Ø 80 mm
- 2 recesses in the width of the table 1200 mm and 1500 mm
- 3 recesses in the width of the table 1800 mm and 2000 mm
- 3 recesses in the corner table top
- including cable entry sets



Table top for column height 740 mm

Table top thickness 27 mm ABS edge

- light gray table top (RAL 7035)
- Hard laminate (EN 438)

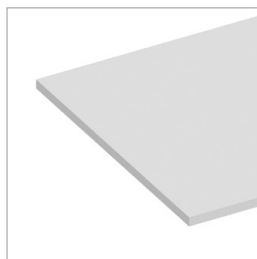

Table depth 800 mm

table width	1200 mm	1500 mm
Standard	604.1200.800.27.0.0	604.1500.800.27.0.0
Standard, ESD	604.1200.800.27.0.1	604.1500.800.27.0.1
incl. cable entry	604.1200.800.27.1.0	604.1500.800.27.1.0
incl. cable entry, ESD	604.1200.800.27.1.1	604.1500.800.27.1.1
incl. cable tray with flap	---	---
incl. cable tray with flap, ESD	---	---

table width	1800 mm	2000 mm
Standard	604.1800.800.27.0.0	604.2000.800.27.0.0
Standard, ESD	604.1800.800.27.0.1	604.2000.800.27.0.1
incl. cable entry	604.1800.800.27.1.0	604.2000.800.27.1.0
incl. cable entry, ESD	604.1800.800.27.1.1	604.2000.800.27.1.1
incl. cable tray with flap	---	---
incl. cable tray with flap, ESD	---	---

Table depth 1000 mm

table width	1200 mm	1500 mm
Standard	604.1200.1000.27.0.0	604.1500.1000.27.0.0
Standard, ESD	604.1200.1000.27.0.1	604.1500.1000.27.0.1
incl. cable entry	604.1200.1000.27.1.0	604.1500.1000.27.1.0
incl. cable entry, ESD	604.1200.1000.27.1.1	604.1500.1000.27.1.1
incl. cable tray with flap	---	---
incl. cable tray with flap, ESD	---	---

table width	1800 mm	2000 mm
Standard	604.1800.1000.27.0.0	604.2000.1000.27.0.0
Standard, ESD	604.1800.1000.27.0.1	604.2000.1000.27.0.1
incl. cable entry	604.1800.1000.27.1.0	604.2000.1000.27.1.0
incl. cable entry, ESD	604.1800.1000.27.1.1	604.2000.1000.27.1.1
incl. cable tray with flap	---	---
incl. cable tray with flap, ESD	---	---

Table top for column height 740 mm

Table top thickness 40 mm postformed edge

- light gray table top (RAL 7035)
- Hard laminate (EN 438)

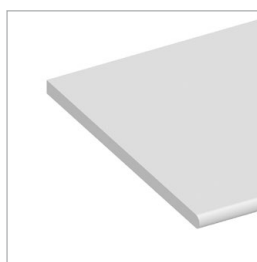

Table depth 800 mm

table width	1200 mm	1500 mm
Standard	604.1200.800.40.0.0	604.1500.800.40.0.0
Standard, ESD	604.1200.800.40.0.1	604.1500.800.40.0.1
incl. cable entry	604.1200.800.40.1.0	604.1500.800.40.1.0
incl. cable entry, ESD	604.1200.800.40.1.1	604.1500.800.40.1.1
incl. cable tray with flap	---	---
incl. cable tray with flap, ESD	---	---

table width	1800 mm	2000 mm
Standard	604.1800.800.40.0.0	604.2000.800.40.0.0
Standard, ESD	604.1800.800.40.0.1	604.2000.800.40.0.1
incl. cable entry	604.1800.800.40.1.0	604.2000.800.40.1.0
incl. cable entry, ESD	604.1800.800.40.1.1	604.2000.800.40.1.1
incl. cable tray with flap	---	---
incl. cable tray with flap, ESD	---	---

Table depth 1000 mm

table width	1200 mm	1500 mm
Standard	604.1200.1000.40.0.0	604.1500.1000.40.0.0
Standard, ESD	604.1200.1000.40.0.1	604.1500.1000.40.0.1
incl. cable entry	604.1200.1000.40.1.0	604.1500.1000.40.1.0
incl. cable entry, ESD	604.1200.1000.40.1.1	604.1500.1000.40.1.1
incl. cable tray with flap	---	---
incl. cable tray with flap, ESD	---	---

table width	1800 mm	2000 mm
Standard	604.1800.1000.40.0.0	604.2000.1000.40.0.0
Standard, ESD	604.1800.1000.40.0.1	604.2000.1000.40.0.1
incl. cable entry	604.1800.1000.40.1.0	604.2000.1000.40.1.0
incl. cable entry, ESD	604.1800.1000.40.1.1	604.2000.1000.40.1.1
incl. cable tray with flap	---	---
incl. cable tray with flap, ESD	---	---

Table top for column height 740 mm

Table top thickness 68/29 mm Postforming edge Premium

- light gray table top (RAL 7035)
- Hard laminate (EN 438)

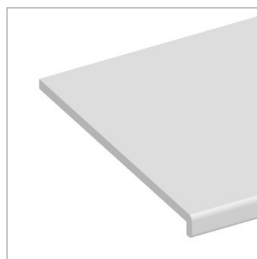

Table depth 800 mm

table width	1200 mm	1500 mm
Standard	604.1200.800.29.0.0	604.1500.800.29.0.0
Standard, ESD	604.1200.800.29.0.1	604.1500.800.29.0.1
incl. cable entry	604.1200.800.29.1.0	604.1500.800.29.1.0
incl. cable entry, ESD	604.1200.800.29.1.1	604.1500.800.29.1.1
incl. cable tray with flap	---	---
incl. cable tray with flap, ESD	---	---

table width	1800 mm	2000 mm
Standard	604.1800.800.29.0.0	604.2000.800.29.0.0
Standard, ESD	604.1800.800.29.0.1	604.2000.800.29.0.1
incl. cable entry	604.1800.800.29.1.0	604.2000.800.29.1.0
incl. cable entry, ESD	604.1800.800.29.1.1	604.2000.800.29.1.1
incl. cable tray with flap	---	---
incl. cable tray with flap, ESD	---	---

Table depth 1000 mm

table width	1200 mm	1500 mm
Standard	604.1200.1000.29.0.0	604.1500.1000.29.0.0
Standard, ESD	604.1200.1000.29.0.1	604.1500.1000.29.0.1
incl. cable entry	604.1200.1000.29.1.0	604.1500.1000.29.1.0
incl. cable entry, ESD	604.1200.1000.29.1.1	604.1500.1000.29.1.1
incl. cable tray with flap	---	---
incl. cable tray with flap, ESD	---	---

table width	1800 mm	2000 mm
Standard	604.1800.1000.29.0.0	604.2000.1000.29.0.0
Standard, ESD	604.1800.1000.29.0.1	604.2000.1000.29.0.1
incl. cable entry	604.1800.1000.29.1.0	604.2000.1000.29.1.0
incl. cable entry, ESD	604.1800.1000.29.1.1	604.2000.1000.29.1.1
incl. cable tray with flap	---	---
incl. cable tray with flap, ESD	---	---

Table top for column height 1600 / 2200 mm

Table top thickness 27 mm ABS edge

- light gray table top (RAL 7035)
- Hard laminate (EN 438)
- with cutouts for QUADRO columns

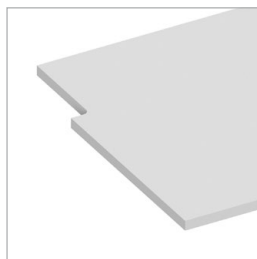

Table depth 800 mm

table width	1200 mm	1500 mm
Standard	604.1200.800.27.3.0	604.1500.800.27.3.0
Standard, ESD	604.1200.800.27.3.1	604.1500.800.27.3.1
incl. cable entry	604.1200.800.27.4.0	604.1500.800.27.4.0
incl. cable entry, ESD	604.1200.800.27.4.1	604.1500.800.27.4.1
incl. cable tray with flap	---	---
incl. cable tray with flap, ESD	---	---

table width	1800 mm	2000 mm
Standard	604.1800.800.27.3.0	604.2000.800.27.3.0
Standard, ESD	604.1800.800.27.3.1	604.2000.800.27.3.1
incl. cable entry	604.1800.800.27.4.0	604.2000.800.27.4.0
incl. cable entry, ESD	604.1800.800.27.4.1	604.2000.800.27.4.1
incl. cable tray with flap	---	---
incl. cable tray with flap, ESD	---	---

Table depth 1000 mm

table width	1200 mm	1500 mm
Standard	604.1200.1000.27.3.0	604.1500.1000.27.3.0
Standard, ESD	604.1200.1000.27.3.1	604.1500.1000.27.3.1
incl. cable entry	604.1200.1000.27.4.0	604.1500.1000.27.4.0
incl. cable entry, ESD	604.1200.1000.27.4.1	604.1500.1000.27.4.1
incl. cable tray with flap	---	---
incl. cable tray with flap, ESD	---	---

table width	1800 mm	2000 mm
Standard	604.1800.1000.27.3.0	604.2000.1000.27.3.0
Standard, ESD	604.1800.1000.27.3.1	604.2000.1000.27.3.1
incl. cable entry	604.1800.1000.27.4.0	604.2000.1000.27.4.0
incl. cable entry, ESD	604.1800.1000.27.4.1	604.2000.1000.27.4.1
incl. cable tray with flap	---	---
incl. cable tray with flap, ESD	---	---

Table top for column height 1600 / 2200 mm

Table top thickness 40 mm postformed edge

- light gray table top (RAL 7035)
- Hard laminate (EN 438)
- with cutouts for QUADRO columns

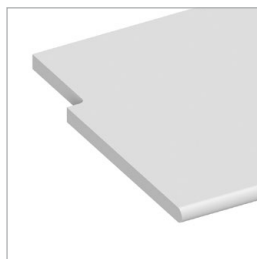

Table depth 800 mm

table width	1200 mm	1500 mm
Standard	604.1200.800.40.3.0	604.1500.800.40.3.0
Standard, ESD	604.1200.800.40.3.1	604.1500.800.40.3.1
incl. cable entry	604.1200.800.40.4.0	604.1500.800.40.4.0
incl. cable entry, ESD	604.1200.800.40.4.1	604.1500.800.40.4.1
incl. cable tray with flap	---	---
incl. cable tray with flap, ESD	---	---

table width	1800 mm	2000 mm
Standard	604.1800.800.40.3.0	604.2000.800.40.3.0
Standard, ESD	604.1800.800.40.3.1	604.2000.800.40.3.1
incl. cable entry	604.1800.800.40.4.0	604.2000.800.40.4.0
incl. cable entry, ESD	604.1800.800.40.4.1	604.2000.800.40.4.1
incl. cable tray with flap	---	---
incl. cable tray with flap, ESD	---	---

Table depth 1000 mm

table width	1200 mm	1500 mm
Standard	604.1200.1000.40.3.0	604.1500.1000.40.3.0
Standard, ESD	604.1200.1000.40.3.1	604.1500.1000.40.3.1
incl. cable entry	604.1200.1000.40.4.0	604.1500.1000.40.4.0
incl. cable entry, ESD	604.1200.1000.40.4.1	604.1500.1000.40.4.1
incl. cable tray with flap	---	---
incl. cable tray with flap, ESD	---	---

table width	1800 mm	2000 mm
Standard	604.1800.1000.40.3.0	604.2000.1000.40.3.0
Standard, ESD	604.1800.1000.40.3.1	604.2000.1000.40.3.1
incl. cable entry	604.1800.1000.40.4.0	604.2000.1000.40.4.0
incl. cable entry, ESD	604.1800.1000.40.4.1	604.2000.1000.40.4.1
incl. cable tray with flap	---	---
incl. cable tray with flap, ESD	---	---

Table top for column height 1600 / 2200 mm

Table top thickness 68/29 mm Postforming edge Premium

- light gray table top (RAL 7035)
- Hard laminate (EN 438)
- with cutouts for QUADRO columns

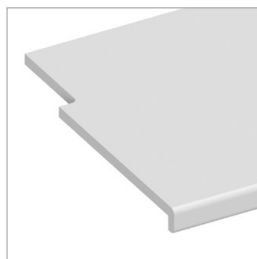

Table depth 800 mm

table width	1200 mm	1500 mm
Standard	604.1200.800.29.3.0	604.1500.800.29.3.0
Standard, ESD	604.1200.800.29.3.1	604.1500.800.29.3.1
incl. cable entry	604.1200.800.29.4.0	604.1500.800.29.4.0
incl. cable entry, ESD	604.1200.800.29.4.1	604.1500.800.29.4.1
incl. cable tray with flap	---	---
incl. cable tray with flap, ESD	---	---

table width	1800 mm	2000 mm
Standard	604.1800.800.29.3.0	604.2000.800.29.3.0
Standard, ESD	604.1800.800.29.3.1	604.2000.800.29.3.1
incl. cable entry	604.1800.800.29.4.0	604.2000.800.29.4.0
incl. cable entry, ESD	604.1800.800.29.4.1	604.2000.800.29.4.1
incl. cable tray with flap	---	---
incl. cable tray with flap, ESD	---	---

Table depth 1000 mm

table width	1200 mm	1500 mm
Standard	604.1200.1000.29.3.0	604.1500.1000.29.3.0
Standard, ESD	604.1200.1000.29.3.1	604.1500.1000.29.3.1
incl. cable entry	604.1200.1000.29.4.0	604.1500.1000.29.4.0
incl. cable entry, ESD	604.1200.1000.29.4.1	604.1500.1000.29.4.1
incl. cable tray with flap	---	---
incl. cable tray with flap, ESD	---	---

table width	1800 mm	2000 mm
Standard	604.1800.1000.29.3.0	604.2000.1000.29.3.0
Standard, ESD	604.1800.1000.29.3.1	604.2000.1000.29.3.1
incl. cable entry	604.1800.1000.29.4.0	604.2000.1000.29.4.0
incl. cable entry, ESD	604.1800.1000.29.4.1	604.2000.1000.29.4.1
incl. cable tray with flap	---	---
incl. cable tray with flap, ESD	---	---

Corner tabletops

Trapezoid

- light gray table top (RAL 7035)
- Hard laminate (EN 438)
- including mounting kit for mounting on the QUADRO columns

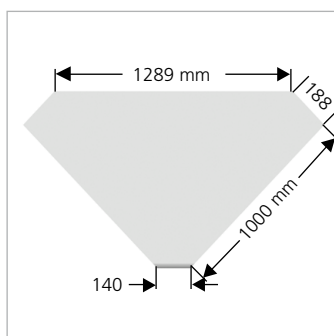
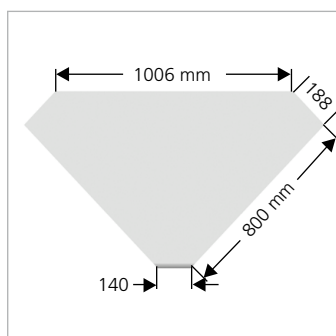

Table top thickness 27 mm ABS edge

table depth	800 mm	1000 mm
Standard	605.800.800.27.0.0	605.1000.1000.27.0.0
Standard, ESD	605.800.800.27.0.1	605.1000.1000.27.0.1
incl. cable entry	605.800.800.27.1.0	605.1000.1000.27.1.0
incl. cable entry, ESD	605.800.800.27.1.1	605.1000.1000.27.1.1

Table top thickness 40 mm postformed edge

table depth	800 mm	1000 mm
Standard	605.800.800.40.0.0	605.1000.1000.40.0.0
Standard, ESD	605.800.800.40.0.1	605.1000.1000.40.0.1
incl. cable entry	605.800.800.40.1.0	605.1000.1000.40.1.0
incl. cable entry, ESD	605.800.800.40.1.1	605.1000.1000.40.1.1

Table top thickness 68/29 mm Postforming edge Premium

table depth	800 mm	1000 mm
Standard	605.800.800.29.0.0	605.1000.1000.29.0.0
Standard, ESD	605.800.800.29.0.1	605.1000.1000.29.0.1
incl. cable entry	605.800.800.29.1.0	605.1000.1000.29.1.0
incl. cable entry, ESD	605.800.800.29.1.1	605.1000.1000.29.1.1

QUADRO twin 700

Height adjustable with spindle drive

- **Table height: height adjustment range 730 - 1070 mm**
- 340 mm height adjustable
- load capacity: max. surface load 200 kg
- including cable tray with integrated privacy screen (except for cable tray with flap)
- electric drive with intelligent control
- cable remote control with digital display and 3 position memories

Consisting of:

- frame
- set of pillars on the left
- set of pillars on the right
- table top

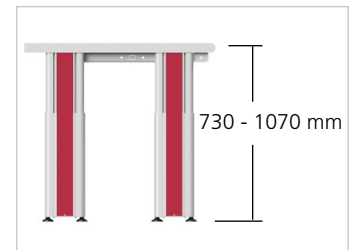

Framework

- steel frame for mounting the table top
- conductive powder-coated, light gray (RAL 7035)
- 4 different table widths
- 2 different table depths



Optional: in ESD design according to IEC 61340-5-1



- grounding box with two 10 mm push-button connections
- central earthing point for connecting the ESD or protective earth



Table depth: 800 mm

table width	1200 mm	1500 mm	1800 mm	2000 mm
Standard	701.1200.800.0	701.1500.800.0	701.1800.800.0	701.2000.800.0
ESD	701.1200.800.1	701.1500.800.1	701.1800.800.1	701.2000.800.1

Table depth: 1000 mm

table width	1200 mm	1500 mm	1800 mm	2000 mm
Standard	701.1200.1000.0	701.1500.1000.0	701.1800.1000.0	701.2000.1000.0
ESD	701.1200.1000.1	701.1500.1000.1	701.1800.1000.1	701.2000.1000.1

QUADRO twin 700

Columns

- QUADRO column made of aluminum as a functional and optical basic element
- height adjustable with spindle drive, 730 - 1070 mm
- conductive powder-coated, light gray (RAL 7035)
- color accents with decorative elements in the pillars
- conductive height adjustment elements in the foot parts
- legroom with corner table combinations thanks to table legs that can be moved to the rear

Consisting of:

- basic pillar
- foot part
- optional add-on column

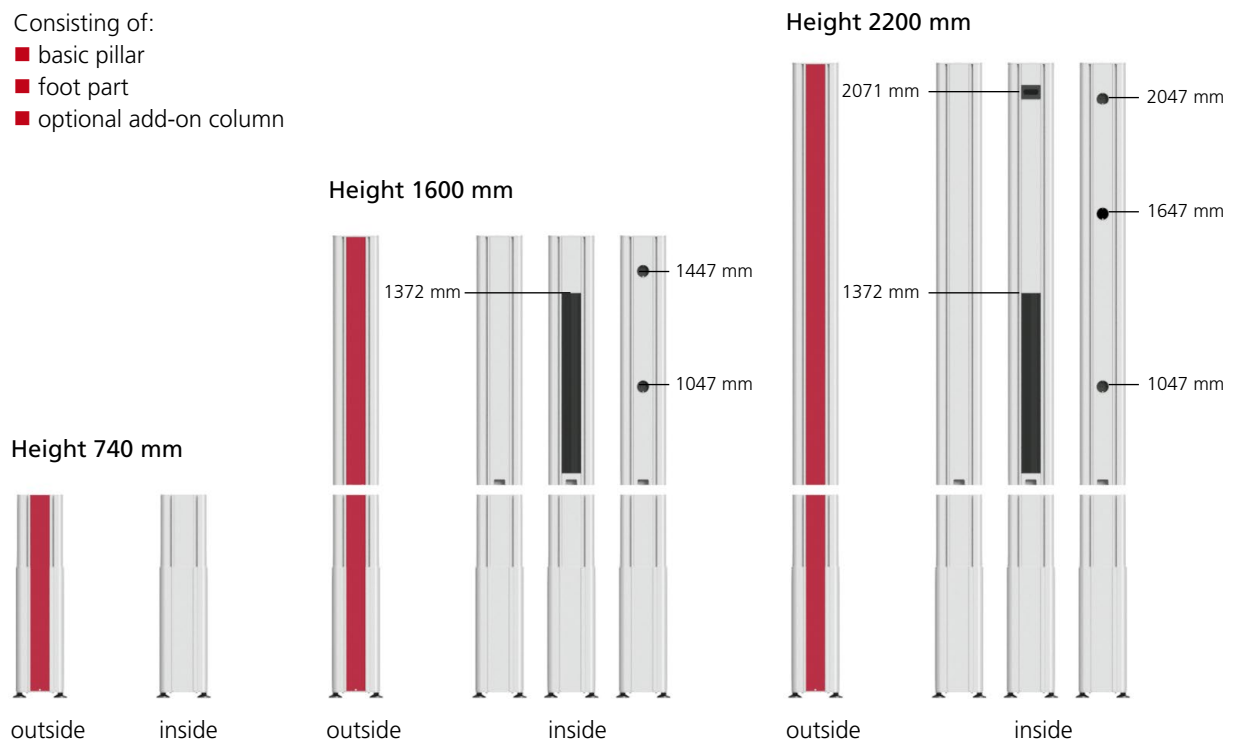

with decorative element	with brush element	with Schuko sockets	with Swiss sockets
Energy, compressed air and data lines can be installed in the two cable ducts of the QUADRO columns be relocated.	Integrated brush strips e.g. for cable routing in connection with cable entry and / or 19" structure.	Integrated Schuko sockets on the inside e.g. for electrifying the upper shelves.	Integrated Swiss sockets on the inside e.g. to electrify the upper shelves.

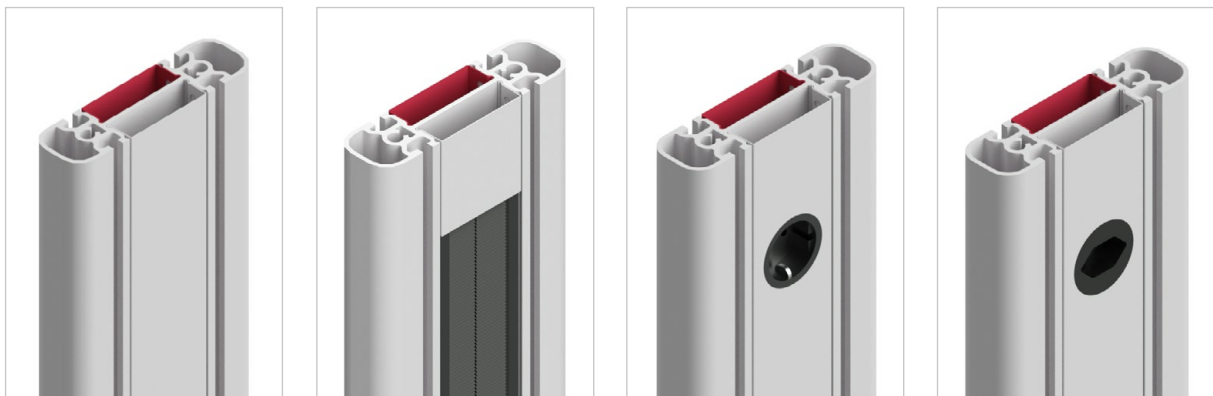

Set of pillars on the left

- QUADRO column made of aluminum as a functional and optical basic element
- height adjustable with spindle drive, 730-1070 mm
- conductive powder-coated, light gray (RAL 7035)
- 3 different column heights

Optional:

- decorative element on the outside
- brush above the table top, on the inside
- sockets above the table top, on the inside
for column height 780 mm / 1600 mm / 2200 mm









Set of pillars on the left

column height	740 / 740 mm	740 / 1600 mm	740 / 2200 mm
without decorative element	---	---	---
decorative element plug-in profile	---	---	---
decorative element snap-in profile	702.740.740.1._ _	702.740.1600.1._ _	702.740.2200.1._ _
brush	---	702.740.1600.2._ _	702.740.2200.2._ _
socket D	---	702.740.1600.3._ _	702.740.2200.3._ _
socket CH	---	702.740.1600.4._ _	702.740.2200.4._ _

Set of pillars on the left - for table top including cable tray with flap

Tabletop thickness	27 mm	29 mm	40 mm
column height	740 / 740 mm	740 / 740 mm	740 / 740 mm
without decorative element	---	---	---
decorative element plug-in profile	---	---	---
decorative element snap-in profile	702.740.740.27.1._ _	702.740.740.29.1._ _	702.740.740.40.1._ _

Please add the color key for the decorative elements to the article number:

	lichtgrau (RAL 7035)	__._._._. 70
	water blue (RAL 5021)	__._._._. 02
	cobalt blue (RAL 5013)	__._._._. 03
	raspberry red (RAL 3027)	__._._._. 04
	zinc yellow (RAL 1018)	__._._._. 06
	pigeon blue (RAL 5014)	__._._._. 08

Other colors for realizing your corporate identity on request

Set of pillars on the right

- QUADRO column made of aluminum as a functional and optical basic element
- height adjustable with spindle drive, 730-1070 mm
- conductive powder-coated, light gray (RAL 7035)
- 3 different column heights

Optional:

- decorative element on the outside
- brush above the table top, on the inside
- sockets above the table top, on the inside
for column height 780 mm / 1600 mm / 2200 mm









Set of pillars on the right

column height	740 / 740 mm	740 / 1600 mm	740 / 2200 mm
without decorative element	---	---	---
decorative element plug-in profile	---	---	---
decorative element snap-in profile	703.740.740.1._ _	703.740.1600.1._ _	703.740.2200.1._ _
brush	---	703.740.1600.2._ _	703.740.2200.2._ _
socket D	---	703.740.1600.3._ _	703.740.2200.3._ _
socket CH	---	703.740.1600.4._ _	703.740.2200.4._ _

Set of pillars on the right - for table top including cable tray with flap

Tabletop thickness	27 mm	29 mm	40 mm
column height	740 / 740 mm	740 / 740 mm	740 / 740 mm
without decorative element	---	---	---
decorative element plug-in profile	---	---	---
decorative element snap-in profile	703.740.740.27.1._ _	703.740.740.29.1._ _	703.740.740.40.1._ _

Please add the color key for the decorative elements to the article number:

	lichtgrau (RAL 7035)	__ . __ . __ . __ . .70
	water blue (RAL 5021)	__ . __ . __ . __ . .02
	cobalt blue (RAL 5013)	__ . __ . __ . __ . .03
	raspberry red (RAL 3027)	__ . __ . __ . __ . .04
	zinc yellow (RAL 1018)	__ . __ . __ . __ . .06
	pigeon blue (RAL 5014)	__ . __ . __ . __ . .08

Other colors for realizing your corporate identity on request

Table tops

- light gray table top (RAL 7035)
- protected with robust edge band
- slightly structured surface, glare-free and highly scratch-resistant
- briefly heat-resistant up to 180°C
- resistant to organic solvents, weak acids and alkalis, gasoline and oil

Standard:

- Hard laminate (EN 438)
- very hard and abrasion-resistant HPL laminate

ESD version:

- conductive ESD Hard laminate (EN 438)
- very hard and abrasion-resistant, conductive HPL laminate
- volume conductive carrier plate
- leakage resistance < 10⁹ Ohm (dry measurement according to nach IEC 61340-5-1, 100 V)



Table top edges / thicknesses

- ABS edge (Acrylnitril-Butadien-Styrol) 27 mm
- Postforming edge 40 mm
- Postforming edge Premium 68/29 mm

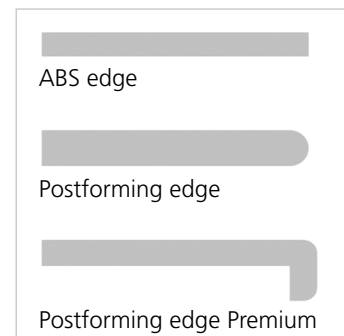

Table top including cable duct

- Ø 80 mm
- 2 recesses in the width of the table 1200 mm and 1500 mm
- 3 recesses in the width of the table 1800 mm and 2000 mm
- 3 recesses in the corner table top
- including cable entry sets



Table top including cable tray with flap

- cable tray integrated in the table top with hinged cover
- cable tray D = 200 mm
- cover divided in the middle for table width 1800 mm und 2000 mm
- with brush strip for cable entry when the cover is closed

Optional:

- Electrical insert strip, prepared for individual assembly with insert plates (page 107)
 - table width 1200 mm: 900 mm usable width for insert panels
 - table width 1500 mm: 1200 mm usable width for insert panels
 - table width 1800 mm: 1500 mm usable width for insert panels
 - table width 2000 mm: 1700 mm usable width for insert panels



Table top for column height 740 mm

Table top thickness 27 mm ABS edge

- light gray table top (RAL 7035)
- Hard laminate (EN 438)

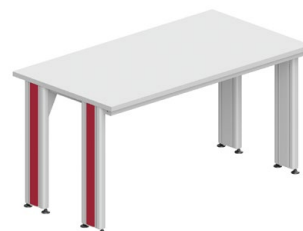
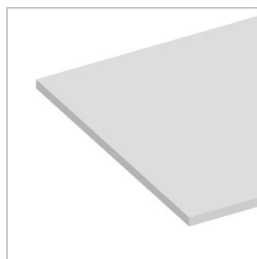

Table depth 800 mm

table width	1200 mm	1500 mm
Standard	704.1200.800.27.0.0	704.1500.800.27.0.0
Standard, ESD	704.1200.800.27.0.1	704.1500.800.27.0.1
incl. cable entry	704.1200.800.27.1.0	704.1500.800.27.1.0
incl. cable entry, ESD	704.1200.800.27.1.1	704.1500.800.27.1.1
incl. cable tray with flap	704.1200.800.27.2.0	704.1500.800.27.2.0
incl. cable tray with flap, ESD	704.1200.800.27.2.1	704.1500.800.27.2.1

table width	1800 mm	2000 mm
Standard	704.1800.800.27.0.0	704.2000.800.27.0.0
Standard, ESD	704.1800.800.27.0.1	704.2000.800.27.0.1
incl. cable entry	704.1800.800.27.1.0	704.2000.800.27.1.0
incl. cable entry, ESD	704.1800.800.27.1.1	704.2000.800.27.1.1
incl. cable tray with flap	704.1800.800.27.2.0	704.2000.800.27.2.0
incl. cable tray with flap, ESD	704.1800.800.27.2.1	704.2000.800.27.2.1

Table depth 1000 mm

table width	1200 mm	1500 mm
Standard	704.1200.1000.27.0.0	704.1500.1000.27.0.0
Standard, ESD	704.1200.1000.27.0.1	704.1500.1000.27.0.1
incl. cable entry	704.1200.1000.27.1.0	704.1500.1000.27.1.0
incl. cable entry, ESD	704.1200.1000.27.1.1	704.1500.1000.27.1.1
incl. cable tray with flap	704.1200.1000.27.2.0	704.1500.1000.27.2.0
incl. cable tray with flap, ESD	704.1200.1000.27.2.1	704.1500.1000.27.2.1

table width	1800 mm	2000 mm
Standard	704.1800.1000.27.0.0	704.2000.1000.27.0.0
Standard, ESD	704.1800.1000.27.0.1	704.2000.1000.27.0.1
incl. cable entry	704.1800.1000.27.1.0	704.2000.1000.27.1.0
incl. cable entry, ESD	704.1800.1000.27.1.1	704.2000.1000.27.1.1
incl. cable tray with flap	704.1800.1000.27.2.0	704.2000.1000.27.2.0
incl. cable tray with flap, ESD	704.1800.1000.27.2.1	704.2000.1000.27.2.1

Table top for column height 740 mm

Table top thickness 40 mm postformed edge

- light gray table top (RAL 7035)
- Hard laminate (EN 438)

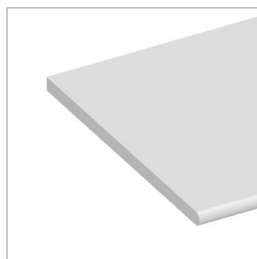

Table depth 800 mm

table width	1200 mm	1500 mm
Standard	704.1200.800.40.0.0	704.1500.800.40.0.0
Standard, ESD	704.1200.800.40.0.1	704.1500.800.40.0.1
incl. cable entry	704.1200.800.40.1.0	704.1500.800.40.1.0
incl. cable entry, ESD	704.1200.800.40.1.1	704.1500.800.40.1.1
incl. cable tray with flap	704.1200.800.40.2.0	704.1500.800.40.2.0
incl. cable tray with flap, ESD	704.1200.800.40.2.1	704.1500.800.40.2.1

table width	1800 mm	2000 mm
Standard	704.1800.800.40.0.0	704.2000.800.40.0.0
Standard, ESD	704.1800.800.40.0.1	704.2000.800.40.0.1
incl. cable entry	704.1800.800.40.1.0	704.2000.800.40.1.0
incl. cable entry, ESD	704.1800.800.40.1.1	704.2000.800.40.1.1
incl. cable tray with flap	704.1800.800.40.2.0	704.2000.800.40.2.0
incl. cable tray with flap, ESD	704.1800.800.40.2.1	704.2000.800.40.2.1

Table depth 1000 mm

table width	1200 mm	1500 mm
Standard	704.1200.1000.40.0.0	704.1500.1000.40.0.0
Standard, ESD	704.1200.1000.40.0.1	704.1500.1000.40.0.1
incl. cable entry	704.1200.1000.40.1.0	704.1500.1000.40.1.0
incl. cable entry, ESD	704.1200.1000.40.1.1	704.1500.1000.40.1.1
incl. cable tray with flap	704.1200.1000.40.2.0	704.1500.1000.40.2.0
incl. cable tray with flap, ESD	704.1200.1000.40.2.1	704.1500.1000.40.2.1

table width	1800 mm	2000 mm
Standard	704.1800.1000.40.0.0	704.2000.1000.40.0.0
Standard, ESD	704.1800.1000.40.0.1	704.2000.1000.40.0.1
incl. cable entry	704.1800.1000.40.1.0	704.2000.1000.40.1.0
incl. cable entry, ESD	704.1800.1000.40.1.1	704.2000.1000.40.1.1
incl. cable tray with flap	704.1800.1000.40.2.0	704.2000.1000.40.2.0
incl. cable tray with flap, ESD	704.1800.1000.40.2.1	704.2000.1000.40.2.1

Table top for column height 740 mm

Table top thickness 68/29 mm Postforming edge Premium

- light gray table top (RAL 7035)
- Hard laminate (EN 438)

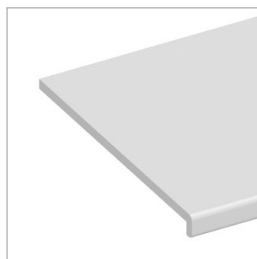

Table depth 800 mm

table width	1200 mm	1500 mm
Standard	704.1200.800.29.0.0	704.1500.800.29.0.0
Standard, ESD	704.1200.800.29.0.1	704.1500.800.29.0.1
incl. cable entry	704.1200.800.29.1.0	704.1500.800.29.1.0
incl. cable entry, ESD	704.1200.800.29.1.1	704.1500.800.29.1.1
incl. cable tray with flap	704.1200.800.29.2.0	704.1500.800.29.2.0
incl. cable tray with flap, ESD	704.1200.800.29.2.1	704.1500.800.29.2.1

table width	1800 mm	2000 mm
Standard	704.1800.800.29.0.0	704.2000.800.29.0.0
Standard, ESD	704.1800.800.29.0.1	704.2000.800.29.0.1
incl. cable entry	704.1800.800.29.1.0	704.2000.800.29.1.0
incl. cable entry, ESD	704.1800.800.29.1.1	704.2000.800.29.1.1
incl. cable tray with flap	704.1800.800.29.2.0	704.2000.800.29.2.0
incl. cable tray with flap, ESD	704.1800.800.29.2.1	704.2000.800.29.2.1

Table depth 1000 mm

table width	1200 mm	1500 mm
Standard	704.1200.1000.29.0.0	704.1500.1000.29.0.0
Standard, ESD	704.1200.1000.29.0.1	704.1500.1000.29.0.1
incl. cable entry	704.1200.1000.29.1.0	704.1500.1000.29.1.0
incl. cable entry, ESD	704.1200.1000.29.1.1	704.1500.1000.29.1.1
incl. cable tray with flap	704.1200.1000.29.2.0	704.1500.1000.29.2.0
incl. cable tray with flap, ESD	704.1200.1000.29.2.1	704.1500.1000.29.2.1

table width	1800 mm	2000 mm
Standard	704.1800.1000.29.0.0	704.2000.1000.29.0.0
Standard, ESD	704.1800.1000.29.0.1	704.2000.1000.29.0.1
incl. cable entry	704.1800.1000.29.1.0	704.2000.1000.29.1.0
incl. cable entry, ESD	704.1800.1000.29.1.1	704.2000.1000.29.1.1
incl. cable tray with flap	704.1800.1000.29.2.0	704.2000.1000.29.2.0
incl. cable tray with flap, ESD	704.1800.1000.29.2.1	704.2000.1000.29.2.1

Table top for column height 1600 / 2200 mm

Table top thickness 27 mm ABS edge

- light gray table top (RAL 7035)
- Hard laminate (EN 438)
- with cutouts for QUADRO columns

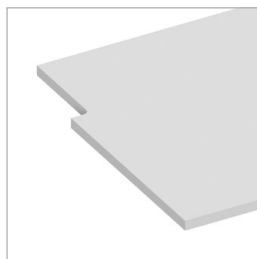

Table depth 800 mm

table width	1200 mm	1500 mm
Standard	704.1200.800.27.3.0	704.1500.800.27.3.0
Standard, ESD	704.1200.800.27.3.1	704.1500.800.27.3.1
incl. cable entry	704.1200.800.27.4.0	704.1500.800.27.4.0
incl. cable entry, ESD	704.1200.800.27.4.1	704.1500.800.27.4.1
incl. cable tray with flap	704.1200.800.27.5.0	704.1500.800.27.5.0
incl. cable tray with flap, ESD	704.1200.800.27.5.1	704.1500.800.27.5.1

table width	1800 mm	2000 mm
Standard	704.1800.800.27.3.0	704.2000.800.27.3.0
Standard, ESD	704.1800.800.27.3.1	704.2000.800.27.3.1
incl. cable entry	704.1800.800.27.4.0	704.2000.800.27.4.0
incl. cable entry, ESD	704.1800.800.27.4.1	704.2000.800.27.4.1
incl. cable tray with flap	704.1800.800.27.5.0	704.2000.800.27.5.0
incl. cable tray with flap, ESD	704.1800.800.27.5.1	704.2000.800.27.5.1

Table depth 1000 mm

table width	1200 mm	1500 mm
Standard	704.1200.1000.27.3.0	704.1500.1000.27.3.0
Standard, ESD	704.1200.1000.27.3.1	704.1500.1000.27.3.1
incl. cable entry	704.1200.1000.27.4.0	704.1500.1000.27.4.0
incl. cable entry, ESD	704.1200.1000.27.4.1	704.1500.1000.27.4.1
incl. cable tray with flap	704.1200.1000.27.5.0	704.1500.1000.27.5.0
incl. cable tray with flap, ESD	704.1200.1000.27.5.1	704.1500.1000.27.5.1

table width	1800 mm	2000 mm
Standard	704.1800.1000.27.3.0	704.2000.1000.27.3.0
Standard, ESD	704.1800.1000.27.3.1	704.2000.1000.27.3.1
incl. cable entry	704.1800.1000.27.4.0	704.2000.1000.27.4.0
incl. cable entry, ESD	704.1800.1000.27.4.1	704.2000.1000.27.4.1
incl. cable tray with flap	704.1800.1000.27.5.0	704.2000.1000.27.5.0
incl. cable tray with flap, ESD	704.1800.1000.27.5.1	704.2000.1000.27.5.1

Table top for column height 1600 / 2200 mm

Table top thickness 40 mm postformed edge

- light gray table top (RAL 7035)
- Hard laminate (EN 438)
- with cutouts for QUADRO columns

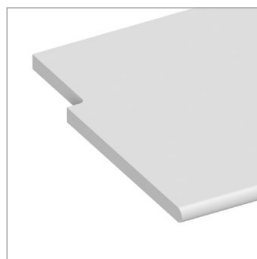

Table depth 800 mm

table width	1200 mm	1500 mm
Standard	704.1200.800.40.3.0	704.1500.800.40.3.0
Standard, ESD	704.1200.800.40.3.1	704.1500.800.40.3.1
incl. cable entry	704.1200.800.40.4.0	704.1500.800.40.4.0
incl. cable entry, ESD	704.1200.800.40.4.1	704.1500.800.40.4.1
incl. cable tray with flap	704.1200.800.40.5.0	704.1500.800.40.5.0
incl. cable tray with flap, ESD	704.1200.800.40.5.1	704.1500.800.40.5.1

table width	1800 mm	2000 mm
Standard	704.1800.800.40.3.0	704.2000.800.40.3.0
Standard, ESD	704.1800.800.40.3.1	704.2000.800.40.3.1
incl. cable entry	704.1800.800.40.4.0	704.2000.800.40.4.0
incl. cable entry, ESD	704.1800.800.40.4.1	704.2000.800.40.4.1
incl. cable tray with flap	704.1800.800.40.5.0	704.2000.800.40.5.0
incl. cable tray with flap, ESD	704.1800.800.40.5.1	704.2000.800.40.5.1

Table depth 1000 mm

table width	1200 mm	1500 mm
Standard	704.1200.1000.40.3.0	704.1500.1000.40.3.0
Standard, ESD	704.1200.1000.40.3.1	704.1500.1000.40.3.1
incl. cable entry	704.1200.1000.40.4.0	704.1500.1000.40.4.0
incl. cable entry, ESD	704.1200.1000.40.4.1	704.1500.1000.40.4.1
incl. cable tray with flap	704.1200.1000.40.5.0	704.1500.1000.40.5.0
incl. cable tray with flap, ESD	704.1200.1000.40.5.1	704.1500.1000.40.5.1

table width	1800 mm	2000 mm
Standard	704.1800.1000.40.3.0	704.2000.1000.40.3.0
Standard, ESD	704.1800.1000.40.3.1	704.2000.1000.40.3.1
incl. cable entry	704.1800.1000.40.4.0	704.2000.1000.40.4.0
incl. cable entry, ESD	704.1800.1000.40.4.1	704.2000.1000.40.4.1
incl. cable tray with flap	704.1800.1000.40.5.0	704.2000.1000.40.5.0
incl. cable tray with flap, ESD	704.1800.1000.40.5.1	704.2000.1000.40.5.1

Table top for column height 1600 / 2200 mm

Table top thickness 68/29 mm Postforming edge Premium

- light gray table top (RAL 7035)
- Hard laminate (EN 438)
- with cutouts for QUADRO columns

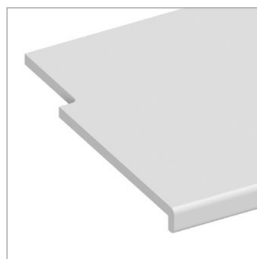

Table depth 800 mm

table width	1200 mm	1500 mm
Standard	704.1200.800.29.3.0	704.1500.800.29.3.0
Standard, ESD	704.1200.800.29.3.1	704.1500.800.29.3.1
incl. cable entry	704.1200.800.29.4.0	704.1500.800.29.4.0
incl. cable entry, ESD	704.1200.800.29.4.1	704.1500.800.29.4.1
incl. cable tray with flap	704.1200.800.29.5.0	704.1500.800.29.5.0
incl. cable tray with flap, ESD	704.1200.800.29.5.1	704.1500.800.29.5.1

table width	1800 mm	2000 mm
Standard	704.1800.800.29.3.0	704.2000.800.29.3.0
Standard, ESD	704.1800.800.29.3.1	704.2000.800.29.3.1
incl. cable entry	704.1800.800.29.4.0	704.2000.800.29.4.0
incl. cable entry, ESD	704.1800.800.29.4.1	704.2000.800.29.4.1
incl. cable tray with flap	704.1800.800.29.5.0	704.2000.800.29.5.0
incl. cable tray with flap, ESD	704.1800.800.29.5.1	704.2000.800.29.5.1

Table depth 1000 mm

table width	1200 mm	1500 mm
Standard	704.1200.1000.29.3.0	704.1500.1000.29.3.0
Standard, ESD	704.1200.1000.29.3.1	704.1500.1000.29.3.1
incl. cable entry	704.1200.1000.29.4.0	704.1500.1000.29.4.0
incl. cable entry, ESD	704.1200.1000.29.4.1	704.1500.1000.29.4.1
incl. cable tray with flap	704.1200.1000.29.5.0	704.1500.1000.29.5.0
incl. cable tray with flap, ESD	704.1200.1000.29.5.1	704.1500.1000.29.5.1

table width	1800 mm	2000 mm
Standard	704.1800.1000.29.3.0	704.2000.1000.29.3.0
Standard, ESD	704.1800.1000.29.3.1	704.2000.1000.29.3.1
incl. cable entry	704.1800.1000.29.4.0	704.2000.1000.29.4.0
incl. cable entry, ESD	704.1800.1000.29.4.1	704.2000.1000.29.4.1
incl. cable tray with flap	704.1800.1000.29.5.0	704.2000.1000.29.5.0
incl. cable tray with flap, ESD	704.1800.1000.29.5.1	704.2000.1000.29.5.1

Corner tabletops

Trapezoid

- light gray table top (RAL 7035)
- Hard laminate (EN 438)
- including mounting kit for mounting on the QUADRO columns

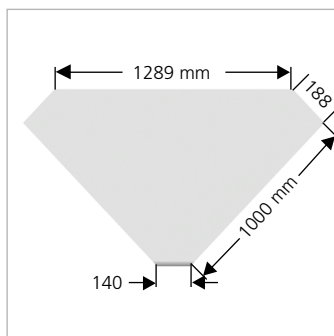
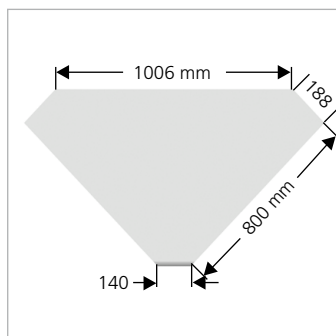

Table top thickness 27 mm ABS edge

table depth	800 mm	1000 mm
Standard	705.800.800.27.0.0	705.1000.1000.27.0.0
Standard, ESD	705.800.800.27.0.1	705.1000.1000.27.0.1
incl. cable entry	705.800.800.27.1.0	705.1000.1000.27.1.0
incl. cable entry, ESD	705.800.800.27.1.1	705.1000.1000.27.1.1

Table top thickness 40 mm postformed edge

table depth	800 mm	1000 mm
Standard	705.800.800.40.0.0	705.1000.1000.40.0.0
Standard, ESD	705.800.800.40.0.1	705.1000.1000.40.0.1
incl. cable entry	705.800.800.40.1.0	705.1000.1000.40.1.0
incl. cable entry, ESD	705.800.800.40.1.1	705.1000.1000.40.1.1

Table top thickness 68/29 mm Postforming edge Premium

table depth	800 mm	1000 mm
Standard	705.800.800.29.0.0	705.1000.1000.29.0.0
Standard, ESD	705.800.800.29.0.1	705.1000.1000.29.0.1
incl. cable entry	705.800.800.29.1.0	705.1000.1000.29.1.0
incl. cable entry, ESD	705.800.800.29.1.1	705.1000.1000.29.1.1

Table extension elements for QUADRO

Boom

- to accommodate running rails, lighting, etc.
- L = 480 mm
- can be mounted on the QUADRO column

	14.105.70
--	------------------



Running rail

- assembly on the boom
- including trolley with eyelet for hanging tools, balancers, etc.
- load capacity: max. 22 kg
- running track can be used continuously on row tables

for Basic table

1300 mm	14.115.70
1650 mm	14.117.70
2135 mm	14.119.70

for add-on table

1300 mm	14.116.70
1650 mm	14.118.70
2135 mm	14.120.70



Storage shelf made of sheet steel

- rounded at the front
- D = 450 mm, H = 40 mm
- infinitely adjustable in height and inclination up to 25 °
- +/- 75 mm depth-variable mountable
- 20 mm high board rail, optionally mountable at the front or at the back
- load capacity: max. surface load 50 kg

table width

1300 mm	14.020.70
1650 mm	14.050.70
2135 mm	14.080.70
Trapezoid	14.095.70



Storage board for gripping trays

- for holding gripping shells (Schäfer system, size 5)
- D = 150 mm
- infinitely variable height mountable
- mountable either horizontally or with a 15 ° incline
- 10 mm high board strip, front and back
- load capacity: max. surface load 25 kg

table width

1300 mm	14.304.70
1650 mm	14.306.70
2135 mm	14.308.70



Carrier rail for socket strips

- to accommodate socket strips
- H = 85 mm, D= 45 mm
- infinitely variable height mountable

table width

1300 mm	14.325.70
1650 mm	14.327.70
2135 mm	14.329.70



Equipment

5-way Schuko socket strip 16 A, 250 V with switch, 1.5 m power cord and Schuko plug	95.005.98
5-way Schuko socket strip 16 A, 250 V with switch 1.5 m power cord and Swiss plug	95.004.98

ESD regulations holder

- suitable for A4 format
- including 10 swiveling, ESD-compatible slip-in sleeves
- W = 280 mm, H = 370 mm
- infinitely variable height can be mounted on the QUADRO colum

	14.619.98
--	------------------



Flat screen bracket

- gas spring supported monitor arm
- weight load: 4 to 9 kg
- VESA standard (75 x 75 mm and 100 x 100 mm)
- max. swivel radius: 550 mm
- height adjustable up to 420 mm

14.614.70

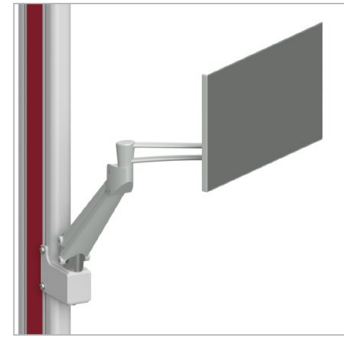

Keyboard drawer

- Installation under the table top
- suitable for all PC keyboards
- W = 495 mm, D = 250 mm
- clear height adjustable from 35 to 70 mm
- extendable by 210 mm
- extendable mouse shelf (W = 180 mm), mountable on both sides

39.465.70



PC tower holder

- can be hooked into the cross connection
- continuously adjustable in width from 125 to 200 mm (clear inner dimension)
- for towers up to a maximum height of 560 mm

14.510.70



QUADRO

Privacy screen

- decorative perforated sheet
- H = 270 mm
- infinitely variable height mountable

table width

1300 mm	14.525.70
1650 mm	14.527.70
2135 mm	14.529.70
Trapezoid	14.535.70



ESD footrest

- can be hooked into the cross connection
- notches for height-adjustable hooking of the footrest
- execution according to DIN 33 406
- inclination steplessly adjustable via foot switch
- inserted, conductive ESD covering for the footrest
- W = 500 mm, D = 340 mm

Footrest pegs	52.320.70
ESD footrest	52.350.70
ESD grounding cable	52.355.98

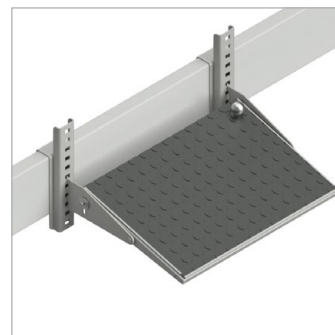

Table extension elements for QUADRO twin

Boom

- for mounting rails, lighting, etc.
- L = 480 mm
- can be mounted on the QUADRO column

	14.105.70
--	------------------



Storage shelf made of sheet steel

- D = 450 mm, H = 40 mm
- infinitely adjustable in height and inclination up to 25 °
- +/- 75 mm depth-variable mountable
- 20 mm high board rail, optionally mountable at the front or at the back
- load capacity: max. surface load 50 kg

for table width

1200 mm	110.150.07
1500 mm	110.150.27
1800 mm	110.150.47
2000 mm	110.150.67
Trapezoid für table depth 800 mm	110.150.77
Trapezoid für table depth 1000 mm	110.150.97



Storage board made of wood

- surface: Formica or ESD hard laminate, light gray
- D = 450 mm, H = 27 mm
- infinitely height and inclination up to 25 ° adjustable
- +/- 75 mm depth-variable mountable
- 20 mm high board rail, optionally mountable at the front or at the back
- load capacity: max. surface load 50 kg

for table width

	Standard	ESD
1200 mm	110.160.00	110.160.01
1500 mm	110.160.20	110.160.27
1800 mm	110.160.40	110.160.41
2000 mm	110.160.60	110.160.61



QUADRO twin

Wooden filing board with terminal

for table width	Standard	ESD
1200 mm	110.165.00	110.165.01
1500 mm	110.165.20	110.165.27
1800 mm	110.165.40	110.165.41
2000 mm	110.165.60	110.165.61

- Terminal for individual equipping with insert plates (page 108)

- table width 1200 mm: 1000 mm usable width for insert panels
- table width 1500 mm: 1200 mm usable width for insert panels
- table width 1800 mm: 1500 mm usable width for insert panels
- table width 2000 mm: 1700 mm usable width for insert panels



Carrier rail for socket strips

- to accommodate socket strips
- H = 85 mm, D = 45 mm
- infinitely variable height mountable

table width	
1200 mm	110.155.07
1500 mm	110.155.27
1800 mm	110.155.47
2000 mm	110.155.67



Cable tray with integrated privacy screen

- for horizontal cable routing under the table top
- as a shelf for socket strips
- H = 215 mm
- already included with QUADRO twin 600 and QUADRO twin 700

for table width	
1200 mm	110.120.07
1500 mm	110.120.27
1800 mm	110.120.47
2000 mm	110.120.67
Corner tabletop for table depth 800 mm	110.120.77
Corner tabletop for table depth 1000 mm	110.120.97

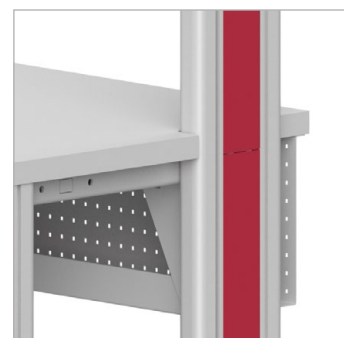

Equipment

5-way Schuko socket strip 16 A, 250 V with switch, 1.5 m power cord and Schuko plug	95.005.98
5-way Schuko socket strip 16 A, 250 V with switch, 1.5 m power cord and Swiss plug	95.004.98

ESD regulations holder

- suitable for A4 format
- including 10 swiveling, ESD-compatible slip-in sleeves
- W = 280 mm, H = 370 mm
- infinitely variable height can be mounted on the QUADRO column

14.619.98



Flat screen bracket

- gas spring supported monitor arm
- Weight load: 4 to 9 kg
- VESA standard (75 x 75 mm and 100 x 100 mm)
- max.swivel radius: 550 mm
- height adjustable up to 420 mm

14.614.70

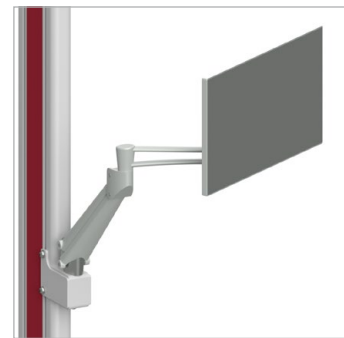

Keyboard drawer

- installation under the table top
- suitable for all PC keyboards
- W = 495 mm, D = 250 mm
- clear height adjustable from 35 to 70 mm
- extendable by 210 mm
- extendable mouse shelf (W = 180 mm), mountable on both sides

39.465.70



QUADRO twin

PC tower holder

- can be mounted under the table top
- continuously adjustable in width from 125 to 200 mm (clear inner dimension)
- for towers up to a maximum height of 485 mm
- load capacity: max. 20 kg

	34.510.70
--	------------------



ESD footrest

- frame made of sturdy square steel tube, H = 450 mm
- notches for height-adjustable hooking of the footrest
- execution according to DIN 33 406
- inclination steplessly adjustable via foot switch
- inserted, conductive ESD covering for the footrest
- W = 500 mm, D = 340 mm

free-standing footrest holder	52.315.70
-------------------------------	------------------

ESD footrest	52.350.70
--------------	------------------

ESD grounding cable	52.355.98
---------------------	------------------



Multifunction arm VARIO

Ergonomically optimal arrangement thanks to:

- 3 self-locking joints
- variable length adjustment of the two swivel arms
- max. swivel radius: 500 mm
- infinitely variable height can be mounted on the QUADRO column
- optional standing or hanging adaptation

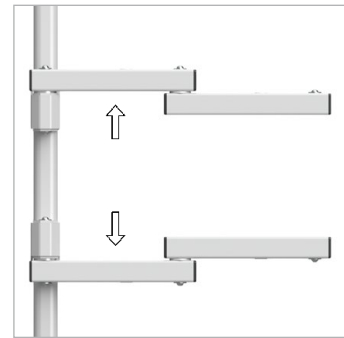

Flat screen bracket

- VESA standard (75 x 75 mm and 100 x 100 mm)
- bracket can be swiveled +/- 90 ° and tilted +/- 15 °
- including multifunction arm
- optionally with keyboard and mouse shelfe

Flat screen bracket	14.610.70
Keyboard tray	39.670.70
Mouse tray (attachment to keyboard tray)	39.672.70



Swiveling storage board

- the inclination is continuously adjustable from 0 ° to 25 °
- board strips on the front and back
- suitable for storing Euro-standard containers
- load capacity: max.surface load 30 kg
- including multifunction arm

415 x 315 mm (W x D), for Euro standard containers 400 x 300 mm	14.635.70
615 x 415 mm (W x D), for Euro standard containers 600 x 400 mm	14.637.70



QUADRO & QUADRO twin

Universal frame

- to accommodate attachable shelves and / or tool holder wall
- clear width: 690 mm
- usable height: 350 mm
- including multifunction arm

14.660.70



Attachable storage board

- can be hung on the universal frame at a variable height
- can be hung horizontally or at a 15° incline
- W = 740 mm, D = 320 mm
- 20 mm high board rail, optionally mountable at the front or at the back
- load capacity: max. surface load 25 kg

39.025.70



Attachable storage board for grab trays

- can be hung on the universal frame at a variable height
- can be hung horizontally or at a 15 ° incline
- for holding grab shells (Schäfer system, size 5)
- W = 740 mm, D = 150 mm
- 10 mm high board strip, front and back
- load capacity: max. surface load 25 kg

39.303.70



Tool holder wall

- can be mounted on the universal frame
- Perforated plate with square holes
- W = 680 mm, H = 340 mm

39.705.70



Equipment:

Tool holder set

39.710.96

(20 hooks and 4 containers in different sizes)

QUADRO & QUADRO twin

Carrier rail for grab trays

- arched support rail for holding 7 gripping trays (Schäfer system, size 5)
- expandable upwards or downwards with additional support rails
- load capacity: max. 30 kg
- including multifunction arm

Support rail (basic element)	14.601.70
Support rail for expansion	14.602.70



Storage board for grab trays

- for holding 5 gripping bowls (Schäfer system, size 5) or the clamshell container
- W = 530 mm, H = 147 mm
- load capacity: max. surface load 30 kg
- including multifunction arm

	14.606.70
--	------------------



Grab tray container

- to be placed on the shelf for grab trays
- 3 rows for 5 gripping bowls each (Schäfer system, size 5)
- 585 x 165 x 335 mm (W x D x H)

	14.611.70
--	------------------

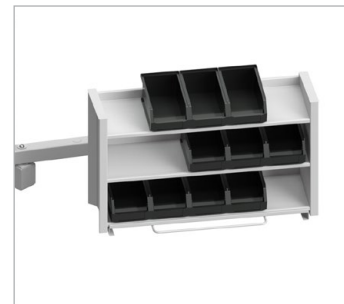

Grab shells

- Schäfer system, size 5
- 95 x 160 x 75 mm (W x D x H)

ESD-black	red	blue	green
96.505.98	96.507.98	96.509.98	96.511.98



QUADRO & QUADRO twin

Drawer blocks

- robust sheet steel housing with central lock
- 4 different carcass heights, 2 different widths, different drawer divisions (1 HU = 54 mm)
- internal dimensions:
W = 330 mm or 520 mm, D = 450 mm
- 4/5 pull-out, drawer guides with steel ball bearings
Load capacity / drawer: max. 30 kg
- ESD-compatible thanks to conductive powder coating, guides and castors
- color accents with decorative elements

Optional:

- fully extendable drawers, drawer guides with telescopic rails, load capacity / drawer: max. 30 kg



Single drawer

- with single lock
- several individual drawers can be mounted one below the other
- H = 110 mm
- D = 551 mm



Drawer division	1 x 2 HU
-----------------	----------

width = 418 mm

QUADRO	12.405._ _
QUADRO twin	120.405._ _

Drawer block F4

- H = 313 mm
- D = 551 mm
- including mounting kit



Drawer division	4 x 1 HU	2 x 1 HU 1 x 2 HU	2 x 2 HU
-----------------	----------	----------------------	----------

width = 418 mm

table depth

QUADRO		12.005._ _	12.010._ _	12.015._ _
QUADRO twin	800 mm	120.005.08._ _	120.010.08._ _	120.015.08._ _
QUADRO twin	1000 mm	120.005.10._ _	120.010.10._ _	120.015.10._ _

width = 606 mm

table depth

QUADRO		13.005._ _	13.010._ _	13.015._ _
QUADRO twin	800 mm	130.005.08._ _	130.010.08._ _	130.015.08._ _
QUADRO twin	1000 mm	130.005.10._ _	130.010.10._ _	130.015.10._ _

QUADRO & QUADRO twin

Drawer block F1

- H = 475 mm
- D = 551 mm
- including mounting kit



Drawer division	7 x 1 HU	2 x 1 HU 1 x 2 HU 1 x 3 HU	1 x 1 HU 3 x 2 HU	1 x 1 HU 2 x 3 HU	1 x 1 HU 1 x 6 HU
-----------------	----------	----------------------------------	----------------------	----------------------	----------------------

width = 418 mm

table depth

QUADRO		12.105._ _	12.110._ _	12.115._ _	12.120._ _	12.125._ _
QUADRO twin	800 mm	120.105.08._ _	120.110.08._ _	120.115.08._ _	120.120.08._ _	120.125.08._ _
QUADRO twin	1000 mm	120.105.10._ _	120.110.10._ _	120.115.10._ _	120.120.10._ _	120.125.10._ _

width = 606 mm

table depth

QUADRO		13.105._ _	13.110._ _	13.115._ _	13.120._ _	13.125._ _
QUADRO twin	800 mm	130.105.08._ _	130.110.08._ _	130.115.08._ _	130.120.08._ _	130.125.08._ _
QUADRO twin	1000 mm	130.105.10._ _	130.110.10._ _	130.115.10._ _	130.120.10._ _	130.125.10._ _

Drawer block F0

- H = 583 mm
- D = 551 mm
- including mounting kit



Drawer division	9 x 1 HU	2 x 1 HU 2 x 2 HU 1 x 3 HU	1 x 1 HU 4 x 2 HU	1 x 1 HU 1 x 2 HU 1 x 6 HU	3 x 3 HU
-----------------	----------	----------------------------------	----------------------	----------------------------------	----------

width = 418 mm

table depth

QUADRO		12.205._ _	12.210._ _	12.215._ _	12.220._ _	12.225._ _
QUADRO twin	800 mm	120.205.08._ _	120.210.08._ _	120.215.08._ _	120.220.08._ _	120.225.08._ _
QUADRO twin	1000 mm	120.205.10._ _	120.210.10._ _	120.215.10._ _	120.220.10._ _	120.225.10._ _

width = 606 mm

table depth

QUADRO		13.205._ _	13.210._ _	13.215._ _	13.220._ _	13.225._ _
QUADRO twin	800 mm	130.205.08._ _	130.210.08._ _	130.215.08._ _	130.220.08._ _	130.225.08._ _
QUADRO twin	1000 mm	130.205.10._ _	130.210.10._ _	130.215.10._ _	130.220.10._ _	130.225.10._ _

QUADRO & QUADRO twin







Mobile drawer block F0

- 4 conductive swivel castors (Ø 52 mm), 2 of which can be locked
- cover plate with conductive rubber covering
- pull-out protection: only one drawer can be opened at a time
- H = 683 mm
- D = 551 mm



Drawer division	9 x 1 HU	2 x 1 HU 2 x 2 HU 1 x 3 HU	1 x 1 HU 4 x 2 HU	1 x 1 HU 1 x 2 HU 1 x 6 HU	3 x 3 HU
width = 418 mm	12.305. __	12.310. __	12.315. __	12.320. __	12.325. __
width = 606 mm	13.305. __	13.310. __	13.315. __	13.320. __	13.325. __

Please add the color key for the decorative elements to the article number:

	lichtgrau (RAL 7035)	__ . __ . __ . .70
	water blue (RAL 5021)	__ . __ . __ . .02
	cobalt blue (RAL 5013)	__ . __ . __ . .03
	raspberry red (RAL 3027)	__ . __ . __ . .04
	zinc yellow (RAL 1018)	__ . __ . __ . .06
	pigeon blue (RAL 5014)	__ . __ . __ . .08

Other colors for realizing your corporate identity on request

ESD insert tray for small parts

- made of conductive plastic
- two trays can be used per drawer
- H = 31 mm

insert tray with 7 compartments for W = 418 mm	96.205.98
insert tray with 11 compartments for W = 606 mm	96.206.98

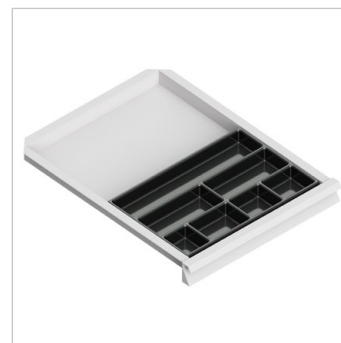

Variable cross and lengthways subdivisions

- adjustable in the grid
- made of powder-coated sheet steel
- H = 73 mm

Transverse subdivisions, W = 330 mm	96.225.70
Transverse subdivisions, W = 520 mm	96.226.70

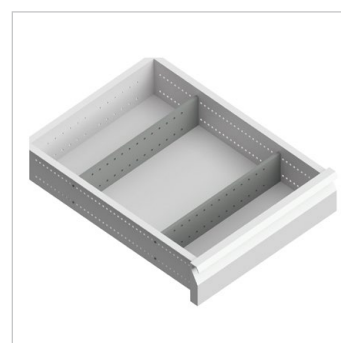

Longitudinal subdivisions, D = 303 mm / A4 landscape	96.227.70
Longitudinal subdivisions, D = 213 mm / A5 landscape	96.229.70
Longitudinal subdivisions, D = 113 mm / A6 landscape	96.231.70



Electrical equipment for QUADRO

19"-superstructures for measuring and testing technology

- optionally stable steel or wooden housing, D = 350 mm, light gray
- infinitely variable height mountable
- back wall with perforations for sufficient ventilation
- grid profiles with standardized spacing for fastening of measuring and testing technology according to DIN 41 494
- for 3 HU or 6 HU subracks

maximum connection value:

- without internal fuse: 16 A / 230 V or 16 A / 400 V
- with internal protection: 25 A / 230 V or 25 A / 400 V

load capacity of the main switching module:

- for alternating current 4.3 kW (AC-1) or 1.3 kW (AC-3)
- for three-phase 13 kW (AC-1) or 5.5 kW (AC-3)

optional:

- Central wiring harness with connectors
- Main switching module with ON and OFF buttons, EMERGENCY STOP, line contactor and control lights
- Lighting in the cross member for glare-free light on the work surface, ON / OFF switch



19"-superstructures made of sheet steel

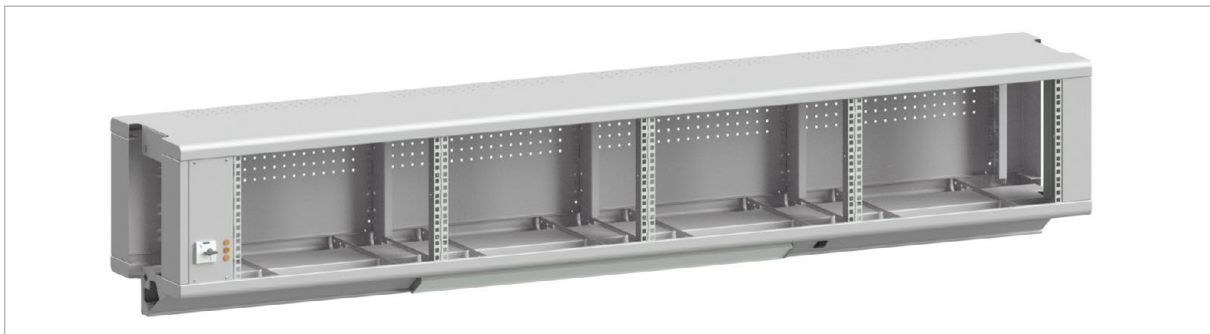

for table width 1650 mm	3 HU	6 HU
without main switching module and central wiring harness	14.205.70	14.245.70
single-phase, with main switching module and central wiring harness	14.215.70	14.255.70
single-phase, with main switching module, central wiring harness and lighting	14.216.70	14.256.70
three-phase, with main switching module and central wiring harness	14.225.70	14.265.70
three-phase, with main switching module, central wiring harness and lighting	14.226.70	14.266.70

for table width 2135 mm	3 HU	6 HU
without main switching module and central wiring harness	14.209.70	14.249.70
single-phase, with main switching module and central wiring harness	14.219.70	14.259.70
single-phase, with main switching module, central wiring harness and lighting	14.220.70	14.260.70
three-phase, with main switching module and central wiring harness	14.229.70	14.269.70
three-phase, with main switching module, central wiring harness and lighting	14.230.70	14.270.70

19"-superstructures made of wood

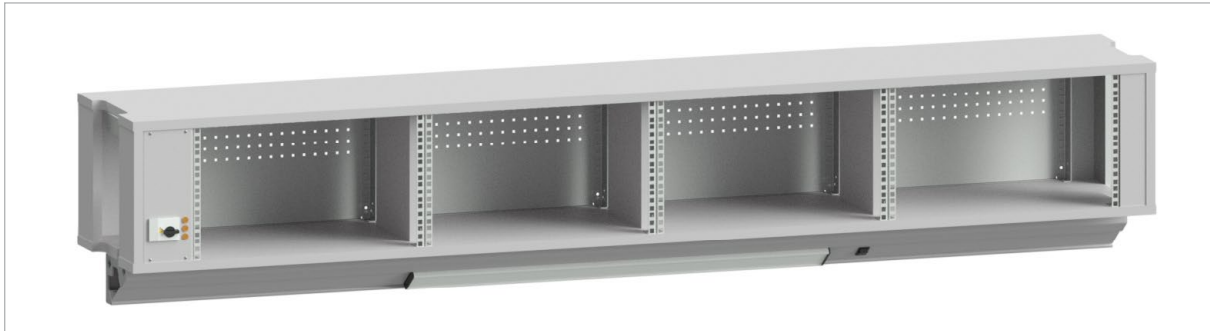

for table width 1650 mm	3 HU	6 HU
without main switching module and central wiring harness	14.205.3	14.245.3
single-phase, without main switching module, with central wiring harness	14.215.3	14.255.3
single-phase, with main switching module and central wiring harness	14.227.3	14.267.3
three-phase, without main switching module, with central wiring harness	14.225.3	14.265.3
three-phase, with main switching module and central wiring harness	14.237.3	14.277.3

for table width 1650 mm, with lighting	3 HU	6 HU
single-phase, without main switching module, with central wiring harness	14.216.3	14.256.3
single-phase, with main switching module and central wiring harness	14.228.3	14.268.3
three-phase, without main switching module, with central wiring harness	14.226.3	14.266.3
three-phase, with main switching module and central wiring harness	14.238.3	14.278.3

for table width 2135 mm	3 HU	6 HU
without main switching module and central wiring harness	14.209.3	14.249.3
single-phase, without main switching module, with central wiring harness	14.219.3	14.259.3
single-phase, with main switching module and central wiring harness	14.231.3	14.271.3
three-phase, without main switching module, with central wiring harness	14.229.3	14.269.3
three-phase, with main switching module and central wiring harness	14.241.3	14.281.3

for table width 2135 mm, with lighting	3 HU	6 HU
single-phase, without main switching module, with central wiring harness	14.220.3	14.260.3
single-phase, with main switching module and central wiring harness	14.232.3	14.272.3
three-phase, without main switching module, with central wiring harness	14.230.3	14.270.3
three-phase, with main switching module and central wiring harness	14.242.3	14.282.3

Please add the key for standard (.0) or ESD version (.4) to the article number

You will find detailed information on the function and supply modules in the brochure „Measurement and Testing Technology“



Electrical connection strips



- stable sheet metal housing in the form of a parapet duct, conductive powder-coated, light gray (RAL 7035)
- for individual fitting with insert plates for energy, data and media supply
- the individual insert plates can be exchanged and expanded at any time
- WINSTA connector system for mains connection and through-wiring
- infinitely variable height mountable
- H = 140 mm, D = 76 mm

Standardized electrical connection strips



- EMERGENCY STOP, circuit breaker, 5 Schuko sockets (D) or Swiss sockets (CH)

for table width 1300 mm	(D)	14.470.70
	(CH)	14.471.70
for table width 1650 mm	(D)	14.473.70
	(CH)	14.474.70
for table width 2135 mm	(D)	14.476.70
	(CH)	14.477.70



- FI 25 A / 30 mA 2-pole, automatic B 16 A 2-pole, EMERGENCY STOP, ON / OFF, mains contactor, 10 Schuko sockets (D) or Swiss sockets (CH)

for table width 1300 mm	(D)	14.480.70
	(CH)	14.481.70
for table width 1650 mm	(D)	14.483.70
	(CH)	14.484.70
for table width 2135 mm	(D)	14.486.70
	(CH)	14.487.70

Electrical connection strips for individual fitting with insert plates

- stable sheet metal housing in the form of a parapet duct, conductive powder-coated, light gray (RAL 7035)
- for energy, data and media supply (page 108)
- the individual insert plates can be exchanged or expanded at any time
- WINSTA connector system for mains connection and through-wiring
- infinitely variable height mountable
- H = 140 mm, D = 76 mm

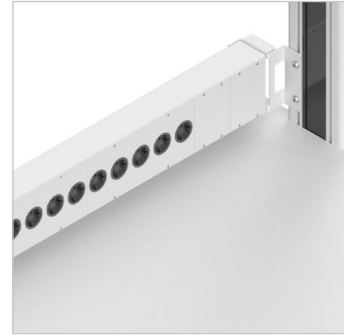

for table width 1300 mm (usable width for insert panels: 1100 mm)	14.450.70
for table width 1650 mm (usable width for insert panels: 1500 mm)	14.453.70
for table width 2135 mm (usable width for insert panels: 1900 mm)	14.456.70

Electrical insert strips for individual fitting with insert plates

- can be integrated into the cable tray with flap
- stable sheet metal housing in the form of a parapet duct, conductive powder-coated, light gray (RAL 7035)
- for energy, data and media supply (page 108)
- the individual insert plates can be exchanged or expanded at any time
- WINSTA connector system for mains connection and through-wiring



for table width 1300 mm (usable width for insert panels: 1100 mm)	14.451.70
for table width 1650 mm (usable width for insert panels: 1400 mm)	14.454.70
for table width 2135 mm (usable width for insert panels: 1800 mm)	14.457.70

Electrical equipment for QUADRO twin

19"-Assemblies for measuring and testing technology, with terminal

- stable conductive wooden housing, D = 350 mm, light gray
- infinitely variable height mountable
- back wall with perforations for sufficient ventilation
- grid profiles with standardized spacing for fastening of measuring and testing technology according to DIN 41 494
- for 3 HU or 6 HU subracks
- central wiring harness with connectors
- main switching module with ON and OFF buttons, EMERGENCY STOP, mains contactor and indicator lights
- terminal for individual equipping with insert plates (page 108)



maximum connection value:

- without internal fuse: 16 A / 230 V or 16 A / 400 V
- with internal protection: 25 A / 230 V or 25 A / 400 V

load capacity of the main switching module:

- for alternating current 4.3 kW (AC-1) or 1.3 kW (AC-3)
- for three-phase 13 kW (AC-1) or 5.5 kW (AC-3)

19"-superstructures made of wood

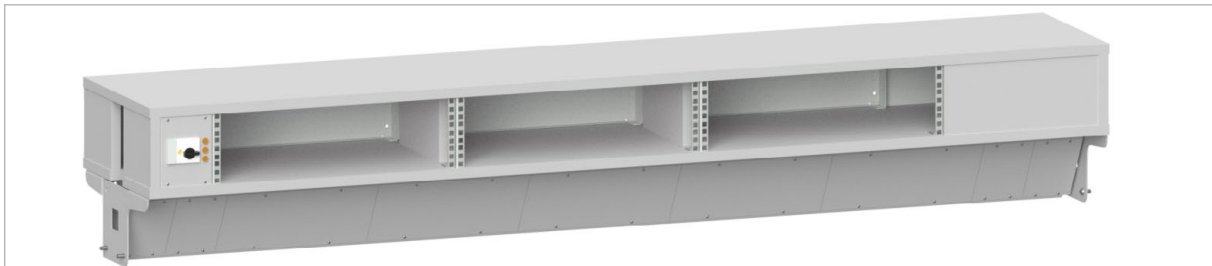

for table width 1800 mm

	3HE	6HE
single phase	150.431.70	150.461.70
three phase	150.433.70	150.463.70

terminal: 1500 mm usable width for insert panels

for table width 2000 mm

	3HE	6HE
single phase	150.631.70	150.661.70
three phase	150.633.70	150.663.70

terminal: 1700 mm usable width for insert panels

LED linear luminaire for terminal

- 1 x 30 W, 870 mm long, light color 4,000 K
- optimal, glare-free illumination of the work surface thanks to swiveling and joint that can be positioned at various depths
- glare reduction through microprismatic disc and diffuser film



1000 mm

95.970.98

Electrical connection strips for individual fitting with insert plates

- stable sheet metal housing in the form of a parapet duct, conductive powder-coated, light gray (RAL 7035)
- for energy, data and media supply (page 108)
- the individual insert plates can be exchanged or expanded at any time
- WINSTA connector system for mains connection and through-wiring
- infinitely variable height mountable
- H = 140 mm, D = 76 mm

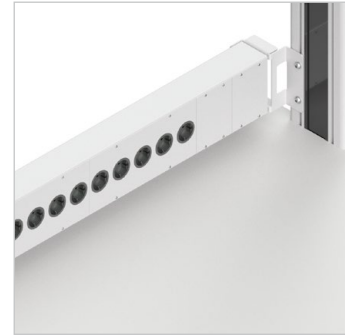

for table width 1200 mm (usable width for insert panels: 1000 mm)	110.450.70
for table width 1500 mm (usable width for insert panels: 1300 mm)	110.453.70
for table width 1800 mm (usable width for insert panels: 1600 mm)	110.456.70
for table width 2000 mm (usable width for insert panels: 1800 mm)	110.459.70

Electrical insert strips for individual fitting with insert plates

- can be integrated into the cable tray with flap
- stable sheet metal housing in the form of a parapet duct, conductive powder-coated, light gray (RAL 7035)
- for energy, data and media supply (page 108)
- the individual insert plates can be exchanged or expanded at any time
- WINSTA connector system for mains connection and through-wiring



for table width 1200 mm (usable width for insert panels: 900 mm)	110.451.70
for table width 1500 mm (usable width for insert panels: 1200 mm)	110.454.70
for table width 1800 mm (usable width for insert panels: 1500 mm)	110.457.70
for table width 2000 mm (usable width for insert panels: 1700 mm)	110.460.70







You will find detailed information on the function and supply modules in the brochure „Measurement and Testing Technology“



QUADRO & QUADRO twin

Insert plates for electrical connection strips





Security modules

	circuit breaker 10-16 A, undervoltage release, Emergency Stop, 1 control lamp, 1-phase	400 mm	(D) (CH)	95.365.70 95.367.70
	circuit breaker 10-16 A, undervoltage release, Emergency Stop, 3 control lights, 3-phase	400 mm	(D) (CH)	95.370.70 95.372.70
	FI 25 A / 30 mA 2-pole, circuit breaker 10-16 A, undervoltage release, Emergency Stop, 1 control lamp, 1-phase	400 mm	(D) (CH)	95.355.70 95.357.70
	FI 25 A / 30 mA 4-pole, circuit breaker 10-16 A, undervoltage release, Emergency Stop, 3 control lights, 3-phase	400 mm	(D) (CH)	95.360.70 95.362.70
	Emergency Stop in a separate housing, 3 m connection cable, circuit breaker 10-16 A, undervoltage release, 1 control lamp, 1-phase	400 mm	(D) (CH)	95.307.70 95.309.70
	Emergency Stop in a separate housing, 3 m connection cable, circuit breaker 10-16 A, Undervoltage release, 3 control lights, 3-phase	400 mm	(D) (CH)	95.312.70 95.314.70
	Emergency Stop, routed to plug connector	100 mm		95.315.70



Switch

	ON / OFF 16 A 2-pole, Rocker switch with indicator light	100 mm		95.405.70
---	---	--------	--	------------------

Blank panels







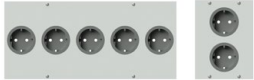

	Blank panel	100 mm		95.205.70
	Blank panel	300 mm		95.210.70
	Blank plate with punching and pre-assembled flush-mounted box	100 mm		95.206.70
	Blank plate with main connection without switching module 1-phase	100 mm		95.620.70
	Blank plate with main connection without switching module 3-phase	300 mm		95.630.70

Compressed air connection

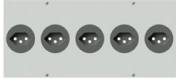



	2 x coupling socket, size 3	100 mm		95.545.70
	2 x coupling socket, size 4	100 mm		95.547.70

QUADRO & QUADRO twin

Sockets

	5 x Schuko socket 2 x Schuko socket		300 mm 100 mm	95.410.70 95.412.70
	5 x Universal socket I, D, USA		300 mm	95.420.70
	5 x Swiss socket		300 mm	95.415.70
	5 x Schuko socket 2 x Schuko socket	red bezel red bezel	300 mm 100 mm	95.440.70 95.442.70
	5 x Universal socket I, D, USA	red bezel	300 mm	95.444.70
	5 x Swiss socket	red bezel	300 mm	95.445.70
	1 x floating socket, Isolating transformer 230 V / 1 A, automatic circuit breaker		300 mm	95.430.70
	1 x CEE 16 A 5-pole		100 mm	95.435.70
	5 safety laboratory sockets, connected to L1, L2, L3, N, PE		100 mm	95.450.70

Data and communication interfaces

	Universal connection RJ45, CAT 6, 2 terminals		100 mm	95.527.70
	2 through connector RJ45, CAT 6		100 mm	95.530.70
	SUB-D connector 9-pin, insulation displacement connection		100 mm	95.505.70
	SUB-D socket 9-pin, insulation displacement connection		100 mm	95.515.70
	2 x through connector USB 2.0 Type A / B reversible		100 mm	95.528.70

Adjustable DC voltage

	0 – 30 V / 0 – 1 A, 2 analog displays		500 mm	95.705.70
	0 – 30 V / 0 – 1 A, 2 digital displays		500 mm	95.707.70

QUADRO & QUADRO twin

Connection cable for electrical connection strips, Installation center, 19"-superstructures and lighting

Power supply

3 m power cable (3 x 1,5 mm ²) with Schuko plug (16 A), 3-pin WINSTA socket	95.625.98
3 m power cable (3 x 1,5 mm ²) with Swiss plug (10 A), 3-pin WINSTA socket	95.627.98
3 m power cable (5 x 2,5 mm ²) with CEE plug (16 A, 5-pin), WINSTA socket 5-pin	95.635.98
7 m power cable (3 x 1,5 mm ²) With Schuko plug (16 A), 3-pin WINSTA socket	95.675.98
7 m power cable (3 x 1,5 mm ²) with Swiss plug (10 A), 3-pin WINSTA socket	95.674.98
3-pin WINSTA socket for on-site cable connection	95.605.98
5-pin WINSTA socket for on-site cable connection	95.607.98
M screw connection set (1 x M 16, 1 x M 20, 1 x M 25) for on-site cable connection	95.615.98

Extension and connection cables

2 m power cable (3 x 1,5 mm ²), WINSTA plug 3-pin, WINSTA socket 3-pin	95.685.98
3 m power cable (3 x 1,5 mm ²), WINSTA plug 3-pin, WINSTA socket 3-pin	95.687.98
4 m power cable (3 x 1,5 mm ²), WINSTA plug 3-pin, WINSTA socket 3-pin	95.689.98
2 m power cable (5 x 2,5 mm ²), WINSTA plug 5-pin, WINSTA socket 5-pin	95.695.98
3 m power cable (5 x 2,5 mm ²), WINSTA plug 5-pin, WINSTA socket 5-pin	95.697.98
4 m power cable (5 x 2,5 mm ²), WINSTA plug 5-pin, WINSTA socket 5-pin	95.699.98
5 m patch cable RJ45; connector 1 x angled, 1 x straight	80.926.98

For connecting further electrical workstation components

3-pin WINSTA snap-in socket including internal wiring after the main switching module	95.645.98
5-pin WINSTA snap-in socket including internal wiring after the main switching module	95.655.98
3-pin WINSTA snap-in socket including internal wiring in front of the main switching module	95.647.98
5-pin WINSTA snap-in socket including internal wiring in front of the main switching module	95.657.98
AC power distributor - 1 x WINSTA plug 3-pin to 3 x WINSTA socket 3-pin	95.600.98
AC power distributor - 1 x WINSTA plug 3-pin to 5 x WINSTA socket 3-pin	95.602.98
AC power distributor - 1 x WINSTA plug 5-pin to 3 x WINSTA socket 5-pin	95.604.98
WINSTA snap-in plug, 3-pin, including internal wiring for separate IT network	95.650.98

EMERGENCY STOP SWITCH

Room Emergency Stop set (additional NC contact for on-site room Emergency Stop loop)	95.300.98
Coupling of 2 Emergency Stop switches (2 additional NC contacts including wiring)	95.301.98

Technical specifications

- maximum connected load without internal protection: 16 A / 230 V bzw. 16 A / 400 V
- maximum connection value with internal protection: 25 A / 230 V bzw. 25 A / 400 V
- Operating current of the circuit breaker: 16 A (AC-3)
- maximum supply line cross-section with internal protection: 4 mm²
- Supply cross-sections without internal protection: 3 x 1,5 mm² with alternating current
5 x 2,5 mm² with three-phase current

QUADRO & QUADRO twin

Lighting

LED linear luminaire

- fixed or suspended connection
- color temperature neutral white 4,000 K
- glare reduction through conical prism screen
- continuously dimmable
- robust housing made of anodized aluminum
- including 3 m power cord with Schuko plug



Luminaire length	900 mm	1200 mm	1500 mm
power	26 W	33 W	40 W

LED linear luminaire with permanent connection

- adjustable incline
- including carrier rail
- can be mounted on the boom

for QUADRO

table width	1300 mm	1650 mm	1650 mm	2135 mm
luminaire length	1200 mm	1200 mm	1500 mm	1500 mm
	14.982.98	14.984.98	14.986.98	14.988.98



for QUADRO twin

table width	1200 mm	1500 mm	1800 mm	2000 mm
luminaire length	900 mm	1200 mm	1500 mm	1500 mm
	110.982.98	110.984.98	110.986.98	110.988.98

boom	14.105.70
------	------------------

LED linear luminaire with drawbar

- infinitely height adjustable
- including carrier rail
- can be mounted on the boom

for QUADRO

table width	1300 mm	1650 mm	1650 mm	2135 mm
luminaire length	1200 mm	1200 mm	1500 mm	1500 mm
	14.983.98	14.985.98	14.987.98	14.989.98



for QUADRO twin

table width	1200 mm	1500 mm	1800 mm	2000 mm
luminaire length	900 mm	1200 mm	1500 mm	1500 mm
	110.983.98	110.985.98	110.987.98	110.989.98

boom	14.105.70
------	------------------

QUADRO & QUADRO twin

LED linear luminaire under the shelf

- adjustable incline
- suitable for storage board made of sheet steel D = 450 mm

luminaire length	900 mm
	14.953.98



LED articulated arm light

- color temperature neutral white 4,000 K
- power consumption 31 W
- robust housing made of anodized aluminum, W = 400 mm
- stepless dimming up to 10%, with memory function
- maximum mobility in all directions thanks to the 3D head joint
- articulated arm length: 384 + 400 mm plus multifunction arm VARIOO

	14.917.98
--	------------------



LED magnifying lamp

- about double magnification by 3.5 diopters
- scratch-resistant glass magnifier with Ø 153 mm for distortion-free viewing
- continuously dimmable up to 10%
- optionally with visualizer function:
 - separately switchable light scenarios for structure-emphasizing effects
- maximum mobility in all directions thanks to the 3D head joint
- articulated arm length: 384 + 400 mm plus multifunction arm VARIO

LED magnifying lamp	14.930.98
with visualizer function	14.932.98
ESD version with visualizer function	14.936.98



Office chairs

ESD chair Basic

- height adjustable from 470 to 610 mm
- according to IEC 61340-5-1
- height-adjustable permanent contact backrest
- base with conductive double castors, braked depending on the load
- hard-wearing, conductive fabric cover
- steel and plastic parts light gray

ESD work chair Basic, upholstery blue	96.137.98
ESD work chair Basic, gray upholstery	96.139.98
Armrests, light gray	96.185.98



ESD chair Sintec

- height adjustable from 430 to 580 mm
- according to IEC 61340-5-1
- height-adjustable permanent contact backrest
- base with conductive double castors, braked depending on the load
- backrest and seat made of volume conductive plastic
- black steel and plastic parts, upholstery optional

Sintec ESD work chair	96.130.98
ESD textile upholstery	96.134.98
ESD integral foam upholstery	96.135.98



ESD chair Neon

- height adjustable from 450 to 620 mm
- according to IEC 61340-5-1
- height-adjustable backrest
- seat depth and seat tilt adjustment
- base with conductive double castors, braked depending on the load
- either: permanent contact backrest or synchronous technology
- black chair element and base, gray flex strip
- upholstery elements can be configured and exchanged quickly

ESD work chair Neon with permanent contact backrest	96.140.98
ESD work chair Neon with synchronous technology	96.142.98
ESD textile upholstery black	96.144.98
ESD integral foam upholstery black	96.146.98

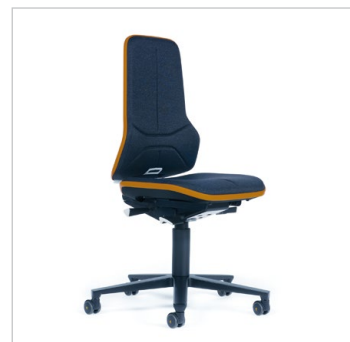

Other chairs on request

QUADRO-CAR



QUADRO-CAR

- as a mobile test station or for material provision
- 4 swivel castors (Ø 100 mm), 2 swivel castors lockable
- width x depth of base frame: 735 x 600 mm
- clear width: 620 mm
- 2 different heights: 1100 mm and 1700 mm
- ESD-compliant as standard thanks to exclusive use of conductive materials
- total weight: max. 200 kg

Optional:

- bottom flap in the foot section to accommodate socket strips
- on the inside of a QUADRO column 800 mm long brush strip for cable entry
- direct passage from the cable duct of the QUADRO column into the hinged bottom flap, also for larger connectors like Schuko angled plug
- bottom flap including 5-way socket strip with 1.5 m power cable
- a QUADRO column with flush integrated, ready-to-connect wired sockets, with connection cable including plug in the foldable floor pan, ideal for power supply electrical devices at different levels
- on the inside of the other QUADRO column 800 mm long brush strip for cable entry

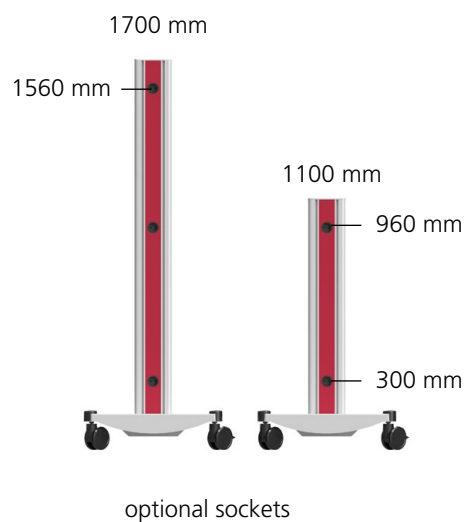
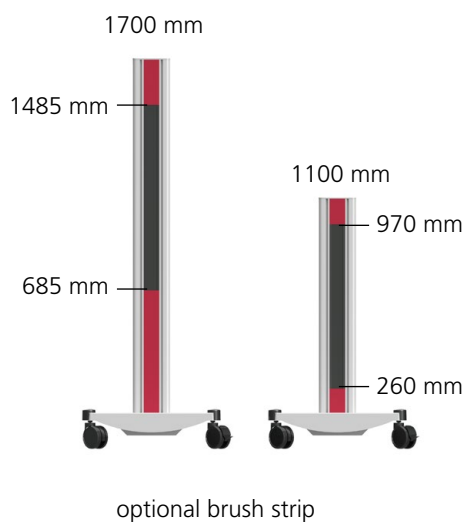

QUADRO-CAR basic equipment

column height 1100 mm	18.405.0_
column height 1700 mm	18.410.0_

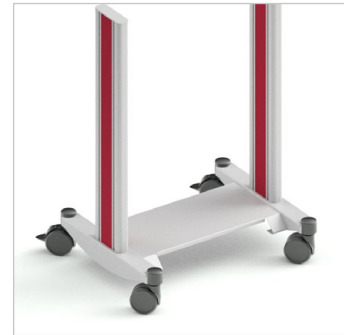

QUADRO-CAR with bottom flap

- integrated brush strip on the inside of a QUADRO column

column height 1100 mm	18.505.0_
column height 1700 mm	18.510.0_



QUADRO-CAR with bottom flap including 5-way socket strip





- integrated sockets on the inside of a QUADRO column
- integrated brush strip on the inside of the other QUADRO column

column height 1100 mm (D)	18.605.0_
column height 1100 mm (CH)	18.705.0_
column height 1700 mm (D)	18.610.0_
column height 1700 mm (CH)	18.710.0_



Please add the color key for the decorative elements to the article number:

Decor color

 water blue (RAL 5021)	__._._._._2
 cobalt blue (RAL 5013)	__._._._._3
 raspberry red (RAL 3027)	__._._._._4
 zinc yellow (RAL 1018)	__._._._._6
 pigeon blue (RAL 5014)	__._._._._8

Other colors for realizing your corporate identity on request

Equipment

5-way Schuko socket strip 16 A, 230 V with switch, 1.5 m power cable and Schuko plug	95.005.98
5-way Swiss socket strip 10 A, 230 V with switch, 1.5 m power cord and Swiss plug	95.004.98
3 m power cable (3 x 1.5 mm ²) with Schuko plug and WINSTA socket	95.625.98
3 m power cable (3 x 1.5 mm ²) with Swiss plug and WINSTA socket	95.627.98

Filing board

- Sturdy shelf made of sheet steel, rounded at the front
- W = 616 mm, H = 40 mm
- infinitely height and inclination up to 25 ° adjustable
- +/- 75 mm depth-variable mountable
- front and back with 20 mm high board strips
- optional: conductive rubber covering to prevent slipping

Standard filing board

- load capacity: max. surface load 50 kg

D = 465 mm	19.405.70
D = 620 mm	19.415.70



Extendable storage board

- load capacity: max. surface load 15 kg
- can be locked in the end positions

D = 620 mm, with mouse tablet	19.470.70
-------------------------------	------------------

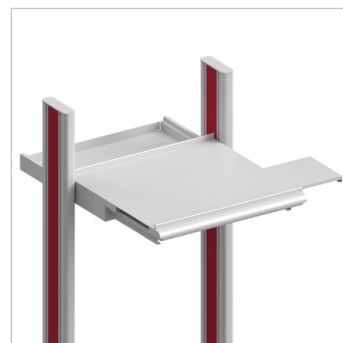

Equipment

Rubber covering for D = 465 mm	19.407.98
Rubber covering for D = 620 mm	19.417.98

19" superstructures made of wood

- stable conductive wooden housing, D = 350 mm, light gray
- infinitely variable height mountable
- back wall with perforations for sufficient ventilation
- grid profiles with standardized spacing for fastening of measuring and testing technology according to DIN 41 494
- for 3 HU or 6 HU subracks
- installation weight: max. 60 kg

optional:

- central wiring harness with connectors
- main switching module with ON and OFF buttons, EMERGENCY STOP, mains contactor and indicator lights



Standard	3 HU	6 HU
without main switching module and central wiring harness	19.905.30	19.915.30
with main switching module and central wiring harness	19.909.30	19.919.30

ESD	3 HU	6 HU
without main switching module and central wiring harness	19.905.34	19.915.34
with main switching module and central wiring harness	19.909.34	19.919.34

You will find detailed information on the function and supply modules in the brochure „Measurement and Testing Technology“



Drawer blocks

- robust sheet steel housing with central lock
- 3 different carcass heights, different drawer divisions (1 HU = 54 mm)
- internal dimensions: W = 520 mm, D = 450 mm
- 4/5 pull-out, drawer guides with steel ball bearings
- Load capacity / drawer: max. 30 kg
- ESD-compatible thanks to conductive powder coating, Guides and castors
- cover plate with conductive rubber covering
- pull-out protection: only one drawer can be opened at a time
- infinitely variable height mountable
- color accents with decorative elements

optional:

- Drawers with full extension, Drawer guides with telescopic rails, Load capacity / drawer: max. 30 kg



Drawer block F4

- H = 349 mm
- D = 540 mm



Drawer division	4 x 1 HU	2 x 1 HU 1 x 2 HU	2 x 2 HU	1 x 4 HU
width = 606 mm	19.505.0_	19.510.0_	19.515.0_	19.520.0_

Drawer block F1

- H = 511 mm
- D = 540 mm



Drawer division	7 x 1 HU	2 x 1 HU 1 x 2 HU 1 x 3 HU	1 x 1 HU 3 x 2 HU	1 x 1 HU 2 x 3 HU
width = 606 mm	19.605.0_	19.610.0_	19.615.0_	19.620.0_

Drawer block F0

- H = 619 mm
- D = 540 mm



Drawer division	9 x 1 HU	2 x 1 HU 2 x 2 HU 1 x 3 HU	1 x 1 HU 4 x 2 HU	1 x 1 HU 1 x 2 HU 1 x 6 HU	3 x 3 HU
width = 606 mm	19.705.0_	19.710.0_	19.715.0_	19.720.0_	19.725.0_





Drawer block with keyboard pull-out

- upper drawer as a keyboard pull-out with a foldable one front panel (3 HU), suitable for all DIN keyboards
- mouse tray that can be pulled out to the right or left
- clamp protection for keyboard cables
- cable entry in the rear wall
- D = 540 mm



carcase height	349 mm	511 mm
additional drawer	1 HU	4 HE
width = 606 mm	19.595.0_	19.695.0_

Please add the color key for the decorative elements to the article number:

Decor color		
	water blue (RAL 5021)	..._..._..._2
	cobalt blue (RAL 5013)	..._..._..._3
	raspberry red (RAL 3027)	..._..._..._4
	zinc yellow (RAL 1018)	..._..._..._6
	pigeon blue (RAL 5014)	..._..._..._8

Other colors for realizing your corporate identity on request

The **KARL-product range.**

Optimal solutions require a precise analysis of the work processes.
KARL defines itself as a system supplier for modern, ergonomic workplace design.

The intensive cooperation and the qualified dialogue with our customers is the basis
for a tailor-made solution for your task.

We also take production-specific requirements and spatial conditions
like the individual needs of each employee into account.

We visualize functionality, ergonomics, handling and implementation of the spatial specifications
in a three-dimensional layout.



QUADRO.
The workplace system for the highest demands.



QUADRO twin.
The classic table system with all options.



SINTRO.
The variable assembly workstation.



SINTRO pack.
The solution for packing stations.



BASIC. The economic workplace system.



Transfer systems.



FIFO shelves. The flexible material feed.



Deployment shelves.



Cupboard and shelf systems.



Measuring and testing technology.

Ergonomics.
Functionality.
Custom design.



Andreas KARL GmbH & Co. KG | Hauptstraße 26 | 85777 Fahrenzhausen | Germany
Telefon: +49 8133 17-0 | Telefax: +49 8133 17-11 | E-Mail: info@karl.eu | www.karl.eu